

# SAFE PATIENT HANDLING



New Intelligent Monitoring System



3000513.D3B02-0125

INVACARE®

# Birdie Compact

Designed to fold easily and without the need for tools, the Birdie Compact can be stored or transported comfortably when space is limited. The compact base and large castors manoeuvre smoothly around beds, in bathroom areas and through narrow doorways. With a weight capacity of 150kg, the Birdie Compact is ideal for everyday lifting in the home or an aged care facility environment. Compact without compromising on comfort.

### EASY HANDLING – FOR THE CARER

The Birdie Compact is only 55 cm wide making it the only lifter that is TÜV certified that is this narrow – unique to the market. The ergonomically designed push bar allows the carer to position their hands comfortably reducing the likelihood of strain. The 100mm smoothing rolling castors make it easy to push and pull the lifter.

### SIMPLE TO FOLD AND UNFOLD WITHOUT TOOLS

The Birdie Compact takes up minimal space when stored reducing clutter in confined spaces. When space is limited, the Birdie Compact can even be stored upright.

### NEW INTELLIGENT SERVICE & MONITORING SYSTEM

The Birdie Compact answers the patient and organisation's need for a safe and comfortable lift with an intelligent service monitoring system built into the control box. This intelligent monitoring system includes a service reminder; emergency operation, audio battery alarm, and battery indicator. The control box also provides a safe and comfortable lift for the client via 'soft start' and 'soft stop' button mechanisms.

### CONFIGURED TO USER NEEDS

Users can enjoy maximum flexibility with a range of spreader bars and a very comfortable sling range, which allows for individual adjustment of the transfer. The new quick release attachment system makes configuration even easier.

### Technical Data

100cm	55cm	89cm	53-160cm
11.5cm	150kg	36kg	100 - 200 cycles*
	3 years frame 2 years electronics and motors 1 year battery		

\*Varies depending upon load and stroke.

### Standard with Lifter:

- 2-point quick attach spreader bar
- Internal charging cable
- External battery charger
- Detachable battery pack

### Accessories:

- 4-point quick attach spreader bar
- Quick attach pivot frame
- Weighing device (250kg SWL)
- Additional battery pack
- Full range of slings

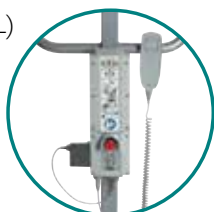

New intelligent monitoring system



Quick release attachments



Tool-less and easy to fold



Store upright to save space

New Intelligent Monitoring System



3000503.E3B00-0125 with Electric Leg Spread  
3000503D3B02-0125 with Manual Leg Spread

# INVACARE® Birdie

With maximum space for the user, the Birdie offers a truly comfortable transfer to or from beds, chairs or even the floor. The Birdie maximises space for the user even when the lifter is in the highest position. The Birdie is available with manual or electric leg adjustment and has a 180kg weight limit, making it ideal for in the nursing or care home environments. Compact without compromising on comfort.

## TOTAL USER COMFORT

The Birdie maximises space for the user, even when the lifter is in the highest position, providing a very comfortable lift and transfer since the user can easily be rotated in the lifter. Consequently, it makes the placing of the user into the bed/wheelchair much easier for the carer. The Birdie is capable of lifting a patient from the floor.

## SIMPLE TO FOLD AND UNFOLD WITHOUT TOOLS

Transporting and storing the lifter has been made as easy as possible as the Birdie can be folded and unfolded without the need for tools or special skills required. You can even store the Birdie upright to take up even less space.









## NEW INTELLIGENT SERVICE & MONITORING SYSTEM

The Birdie Compact answers the patient and organisation's need for a safe and comfortable lift with an intelligent service monitoring system built into the control box. This intelligent monitoring system includes a service reminder, emergency operation, audio battery alarm, and battery indicator. The control box also provides a safe and comfortable lift for the client via 'soft start' and 'soft stop' button mechanisms.

## CONFIGURED TO USER NEEDS

Users can enjoy maximum flexibility with a range of spreader bars and a very comfortable sling range, which allows for individual adjustment of the transfer. The new quick release attachment system makes configuration even easier.

## Technical Data

 115cm	 68 cm	 104cm	 47 - 174cm
 11.5cm	 180kg	 42kg	 100 - 200 cycles*
 3 years frame 2 years electronics and motors 1 year battery			

\*Varies depending upon load and stroke.

## Standard

- 2-point quick attach spreader bar
- Internal charging cable
- External battery charger
- Detachable battery pack

## Accessories

- 4-point quick attach spreader bar
- Quick attach pivot frame
- Weighing device (250kg SWL)
- Additional battery pack
- Full range of slings

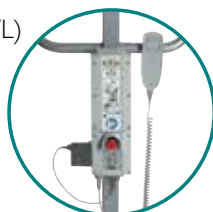

New intelligent monitoring system



Quick release attachments



Long boom - high user comfort



Electric leg adjustment

# INVACARE® Jasmine



Jasmine Kit

The Invacare **Jasmine** Mobile Lift is a flexible solution that offers high comfort for all clients. The lift covers all needs, providing safe patient handling with up to 200 kg weight capacity. With its expansive, wide opening base and high lifting mechanism, **Jasmine** makes life easy for caregivers operating this new Invacare lift system. The control box with diagnostic system is an intelligent service monitoring system that enables a safe operating environment for the caregiver, whilst allowing maximum comfort for the client during each transfer.

## FLEXIBILITY AND OPTIMIZED MANEUVERABILITY

The Invacare **Jasmine** is exceptionally mobile and easy to move around. The wide-opening base allows easy access for a wheelchair or armchair, whilst the high lifting mechanism is essential for helping clients on and off high toilet chairs or examination couches. Flexible and with optimized maneuverability, **Jasmine** covers all needs, at all times – for both the caregiver and the client.









## SAFETY FIRST, WITH AN INTELLIGENT CONTROL BOX

**Jasmine** secures the patient's need for a safe and comfortable lift with control box with diagnostic system: an intelligent service monitoring system that highlights the battery status and service condition of the actuator to ensure safe patient handling. The control box provides a safe and comfortable lift for the client via 'soft start' and 'soft stop' button mechanisms.

## ACCESSORIES FOR ALL SITUATIONS

Users can enjoy maximum flexibility with a range of spreader bars, pivot bars and a very comfortable sling range that allows for individual adjustment of the transfer.

### Technical Data

			
134cm	69cm	105cm	54cm-192cm
			
12cm	200kg	43kg	40 cycles
	3 years frame 2 years electronics and motors 1 year battery		

\*Varies depending upon load and stroke.

### Standard

- 2-point spreader bar
- External battery charger
- Detachable battery pack

### Accessories

- 4-point spreader bar
- Weighing device (300kg SWL)
- Pivot frame
- Additional battery pack
- Full range of slings



**New intelligent monitoring system**  
Includes a service reminder, emergency operation, audio battery alarm, and battery indicator.



**Comfort for the user**  
Full lift range and good clearance for the user.



**Electric leg adjustment**  
Easy and effortless solution for positioning lifter when transferring a user.



# INVACARE®

## Roze

New Intelligent Monitoring System



1156359

We leave the lifting to the lifter. The Invacare Roze Standup Lifter is compact and manoeuvrable and provides an easy, safe and comfortable assisted transfer for patients in care or those with rehabilitation needs. With its numerous safety features, the Roze Standup Lifter ensures caregiver security and resident peace of mind. Whether in the home, aged care facility or hospital, the Roze is the ideal stand-up lifter for the daily transferring of patients.

### COMFORTABLE AND SECURE

Knowing the patient is comfortable creates confidence in the carer to use the Lifter; and therefore reduces manual handling injuries. The Roze features an ergonomic lift angle, designed to minimise shear when lifting a patient. The grip handles on the lifting boom enable the user to adjust their hand position, making the patient feel comfortable and secure during raising and lowering.

### NEW INTELLIGENT SERVICE & MONITORING SYSTEM

The Roze answers the patient and organisation's need for a safe and comfortable lift with an intelligent service monitoring system built into the control box. This intelligent monitoring system includes a service reminder, emergency operation, audio battery alarm, and battery indicator. The control box also provides a safe and comfortable lift for the client via 'soft start' and 'soft stop' button mechanisms.

### SAFE AND RELIABLE

The single position hook makes for simple and easy sling attachment plus a safety clip prevents the sling from disengaging. Added safety features include an emergency stop button, an emergency mechanical descent system and an anti-entrapment device, (which stops the boom lowering if it meets resistance). The Roze has been tested to AS10535.2002 (the Australian standard for hoists) and to ISO10535.2006.

### Technical Data



112cm



66cm



105cm



94 - 161cm



12cm



200kg



53kg



100-200 cycles\*



3 years frame  
2 years electronics and motors  
1 year battery

\*Varies depending upon load and stroke.

### Standard

- Internal charging cable
- External battery charger
- 2x Detachable battery packs

### Accessories

- Additional battery pack
- Full range of standup slings



New intelligent monitoring system

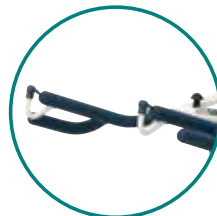

Comfortable grip for patient



Ergonomic push handle



Compact base

# INVACARE® Lifter Accessories

	Fits to the new <b>Birdie</b> and <b>Birdie Compact</b> Lifters. <b>New Quick Release Design</b>	Fits to the <b>ELF127EM, IPL150EE, IPL205EE, Omega 300 EE</b> and selected other Invacare/Promed Lifters.
<p><b>2 Point Spreader Bars</b></p> <p>Recommend for most common lifting requirements and for use with most slings. Comes standard with all Invacare Lifters.</p>	 <p>1526582-0125</p>	 <p>LBS-19100</p>
<p><b>4 Point Spreader Bars</b></p> <p>Suitable when larger spacing between back and leg is required. It also facilitates a more reclined sitting posture. The 4-point spreader bar works best with slings that have head support. A good option when lifting and transferring larger patients.</p>	 <p>1526584-0125</p>	 <p>LBS-18384</p>
<p><b>Pivot Frames</b></p> <p>The Pivot Frame allows the whole frame to be tilted back and forward to assist in the positioning of the patient. Assists with the lifting of a patient in either a sitting or lying position, ideal for lifting on and off a bed or the floor. The Pivot Frame can only be used with the Invacare range of Pivot Slings.</p>	 <p>1156099</p>	 <p>LBP-17012</p>
<p><b>Weighing Devices</b></p> <p>Accurately and easily weigh patients during daily transfers. The weighing devices connect above the spreader bar and are easy to use and read.</p>	 <p>1513627</p>	 <p>LZW-WD070</p>
<p><b>Lifting Frame</b></p> <p>Suitable when a horizontal lift is required. Comes with carry case and lifting straps. <b>Use only with the Invacare Omega 300 lifter with 4-point spreader bar (LBS-18384).</b></p>	 <p>LBP-17201</p>	

# INVACARE® Sling Collection

Invacare Slings are designed to be simple and safe to use for both home and institutional patient lifting. The slings are manufactured from polyester fabric or mesh (suitable for bathing) with internal padding in pressure areas and utilises webbing attachment loops or keyhole buckles. The sling attachment straps are colour coded for sizing to allow easy sling selection and identification.

To be used by a qualified carer in conjunction with an appropriate Invacare patient lifting device to support patients with disabilities. Patients must be within the capacity indicated on the sling. The carer must adhere to the usage guidelines identified in the relevant slings instruction manual. All slings come with a one year limited warranty.

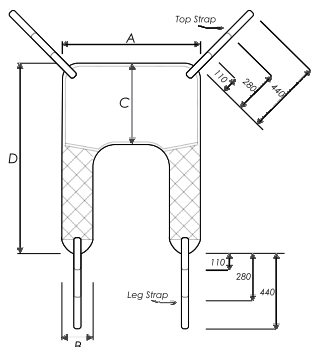

## General Purpose Sling

is available in four sizes in a choice of fabric or mesh. The sling provides easy fitting and good support for patients with some upper body control.

Recommended for general lifting.  
Colour: Navy



	S	M	L	XL	
A	820	920	1110	1270	
B	230	220	260	260	
C	490	530	650	730	
D	1180	1240	1360	1520	
<b>Code:</b>	Fabric	17105	17041	17043	17204
	Mesh	17123	17124	17125	N/A

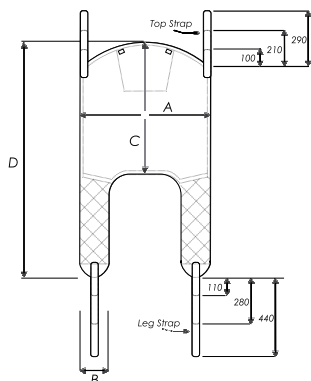

## General Purpose Sling with Head Support

is available in six sizes in a choice of fabric or mesh. The sling fits easily to a patient in bed or a chair, providing excellent upper body and head support.

Recommended for lifting from the floor and general lifting of the less secure patient.  
Colour: Navy



	XS	S	M	L	XL	XXL	
A	820	830	970	1140	1310	1420	
B	190	230	230	250	260	270	
C	760	790	920	990	1000	1060	
D	1290	1330	1450	1680	1720	1850	
<b>Code:</b>	Fabric	17209	17247	17067	17069	17205	N/A
	Mesh	N/A	17126	17127	17128	17248	17212

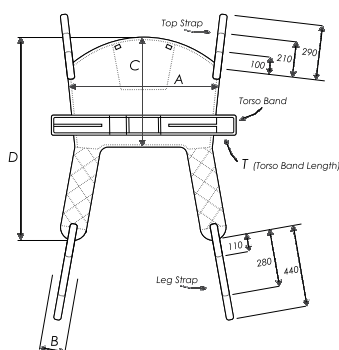

## General Purpose Hygiene Sling with Head Support

is available in five sizes in a choice of fabric or mesh. The sling enables easy removal of clothing or toilet transfers.

Recommended for general toilet transfers for the less secure patient.  
Colour: Navy



	XS	S	M	L	XL	
A	670	900	1030	1100	1180	
B	160	190	190	190	200	
C	550	620	690	800	830	
D	890	1150	1230	1430	1440	
T	980	1140	1180	1320	1440	
<b>Code:</b>	Fabric	N/A	17402	17395	17396	17403
	Mesh	17405	17406	17358	17359	17407

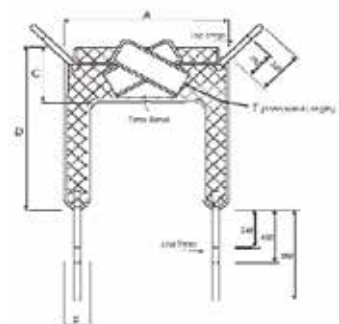

## Supreme Hygienic Sling

is available in three sizes and comes in fully quilted fabric only. This sling is excellent for transfers onto a toilet as it provides an open area from the middle of the back to the middle of the thigh. This sling has a buckle waist strap and features generous padding around the patient's mid-section and under arms.

Recommended for general toilet transfers.  
Colour: Navy (previously Green)



	S	M	L	
A	730	870	950	
B	140	140	150	
C	320	330	330	
D	810	1010	990	
T	1180	1340	1470	
<b>Code:</b>	Fabric	17530	17531	17532

# INVACARE® Sling Collection

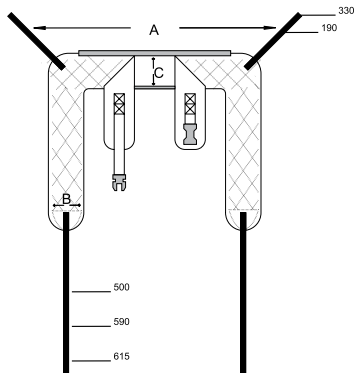

## Hygienic Sling

is available in two sizes and comes in fully quilted fabric only. This sling is excellent for transfers onto a toilet as it provides an open area from the middle of the back to the middle of the thigh. This sling has a buckle waist strap and features generous padding around the patient's midsection and under arms.



Recommended for general toilet transfers.

Colour: Navy (previously Green)

	M	L
A	870	950
B	140	150
C	330	330
D	1010	990
T	1340	1470

**Code:** Fabric THYM THYL

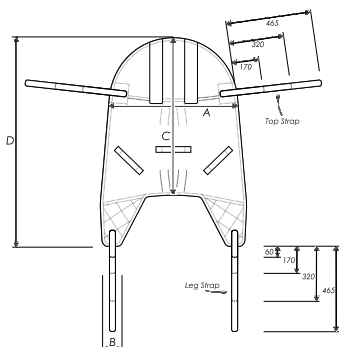

## Paediatric Sling

is available in three sizes in mesh only. The sling provides easy fitting and good support for children or small adults.



Recommended for general lifting with children or small adults.

Colour: Navy

	XS	S	M
A	580	750	760
B	100	100	100
C	720	880	950
D	1050	1190	1380

**Code:** Mesh 17260 17262 17266

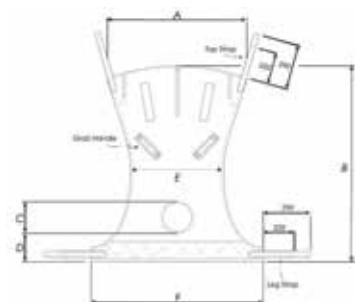

## Hammock Sling

is available in two sizes in a choice of fabric and mesh with a commode hole. The sling provides ultimate support and security for lifting from a bed or the floor: The patient must roll on to, and off, the sling. When fitted full head support is provided.



Recommended for single or double lower limb amputees and lifting from the floor because weight is not taken by the patient's thighs.

Colour: Navy

	M	L
A	890	1020
B	N/A	N/A
C	930	1070
D	1170	1260

**Code:** Fabric 17335 N/A  
Mesh 17336 17129

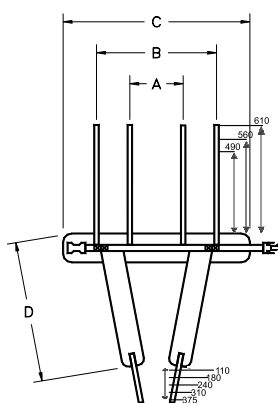

## Walking Sling

is available in one size in fabric only. The sling is designed to assist people with limited ability to walk, this sling helps support and assist in rehabilitation. Fully padded with a security buckle, the sling is comfortable and simple to use. The user must have weight bearing ability.



Recommended for walking in a rehabilitation environment only.

Colour: Navy (previously Green)

	M
A	1060
B	690
C	310
D	910
T	1220

**Code:** Fabric TEM-M



# INVACARE® Sling Collection

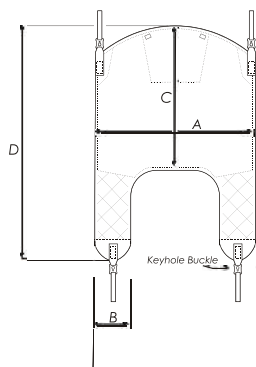

## Pivot Sling

is available in five sizes in a choice of fabric or mesh. The sling allows a patient to be lifted in either a sitting or lying position. The ability to position a patient in the sitting posture greatly assists correct seating. A more open lift.

Recommended for general lifting including floor lifting.  
Colour: Navy



	XS	S	M	L	XL	
A	700	900	1010	1080	1280	
B	180	230	250	250	270	
C	590	790	890	990	1110	
D	840	1180	1310	1400	1590	
Code:	Fabric	N/A	17133	17134	17135	17136
	Mesh	17240	17241	17242	17243	17244

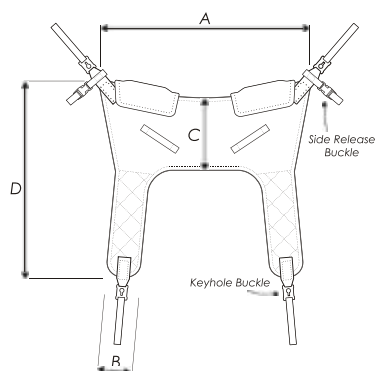

## Pivot Sling Hygiene

is available in two sizes in mesh only. The sling provides easy removal of clothing for toilet transfers and bathing.

Recommended for general toilet transfers and bathing.  
Colour: Navy



	M	L	
A	820	1170	
B	140	170	
C	270	280	
D	760	790	
Code:	Mesh	17392	17393

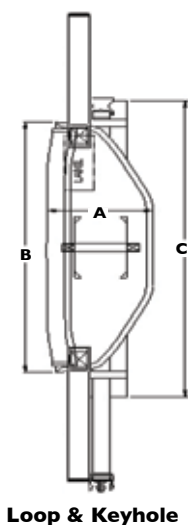

## Standup Slings

The Invacare Standup Slings are designed to lift the patient comfortably from a seated position into a relaxed upright position. Recommended for patients with a reasonable level of weight bearing ability.

There are two types of slings available, based on whether it is a loop or keyhole attachment.

### Loop attachment sling

Designed for use with the Invacare Roze stand-up lifter.

### Keyhole attachment sling

Designed for use with the Invacare RPS440 stand-up lifter.



	M Buckle	L Buckle	UNI Velcro
A	240	340	340
B	820	1000	1000
C	1200	1270	1700
Loop :	Fabric	18710	18711
	Keyhole: Fabric	17610	17611

## GENERAL PURPOSE SLINGS

Webbing loops of varying lengths are provided at each connection point to allow a lay back posture for the patient or by using the shortest loops, a higher lift. General purpose slings SWL: XS - M = 205kg L - XXL = 300kg

## PIVOT SLINGS

Special slings known as Pivot Slings are required for use with the Pivot Frames. The slings are manufactured from polyester fabric or mesh (suitable for bathing). These slings allow the patient to be lifted in either a sitting or lying position, ideal for lifting on and off a bed or the floor.

The unique pivot with anti-lock at the end of the boom allows the whole frame to be rocked back and forward to assist with the correct positioning of the patient. The frame spreads the sling attachment points to ensure the patient's hips are not excessively flexed, avoiding the discomfort obese patients sometimes experience with standard slings. Pivot slings SWL: XS - XXL = 205kg

# Safety first, with an Intelligent Monitoring System

The Invacare Birdie Compact, Birdie, Jasmine and Roze lifters now come with a new intelligent service and monitoring system. The system (built into the control box) has the ability to monitor service intervals, much like a servicing warning in a vehicle. It will help ensure compliance to ANZ Standards (10535.2002) that requires a lifter is serviced at least once every 12 months. It will also now be possible to know exactly how much the lift has been used – based on factual data. This can help in maximizing the use of the lifter within a facility and the rotating of rental or refurbished equipment. It will now be possible to switch the actuator in time to keep equipment going, helping to reduce the number of unexpected service visits.

## How it Works

- A service interval is set when the lifter is made operational. The service interval can be set to the organizations requirements but at least every 12 months.
- When the service is due the light indicator on the control box will remain on for 2 minutes when the lifter is used.
- Following the maintenance check the Service Indicator is reset ready for the next service
- It is that simple

If additional full diagnostics is required (actuator life, number of lift cycles, total work) a PC diagnostic hardware and software kit is available. This kit enables the connection of a laptop to the lifter control-box providing additional diagnostics and monitoring tools.

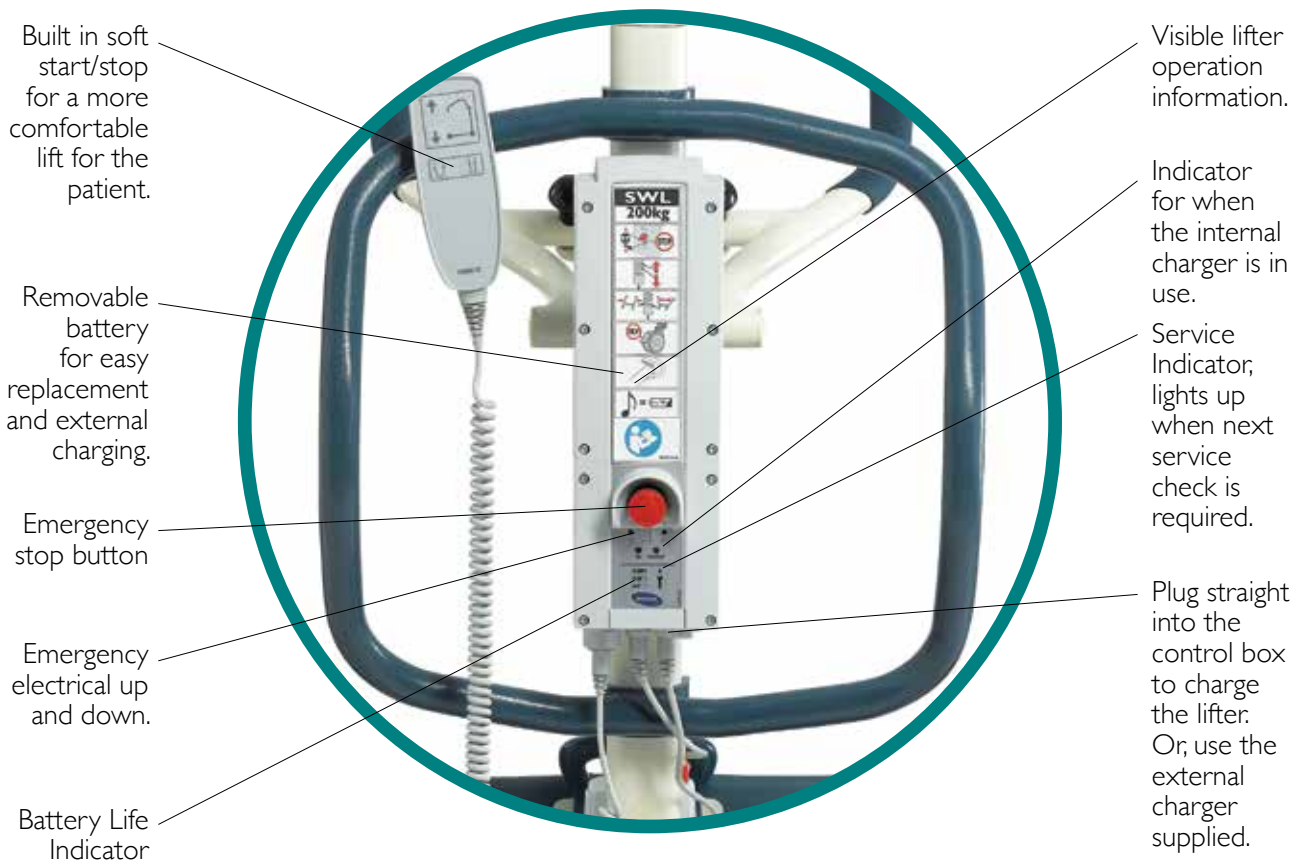

# NOTES

# INVACARE®

## COMPANY PROFILE

INVACARE CORPORATION traces its roots back to 1885 when the Worthington Company began producing a line of vehicles designed for people with physical disabilities. Through the years, the complexion of the company has changed several times and the product range has expanded dramatically.

Today, Invacare is the global leader in the \$6 billion market for home medical products, manufacturing and distributing the world's broadest product offering to approximately 15,000 independent, home medical equipment providers.

Since establishment in Australia, Invacare has grown both organically and through the acquisition of several trusted and well known Australian brands including: Roller Chair; Pro-Med; Decpac; Australian Healthcare Equipment (Murphy Furniture and Hencicare Hospital Equipment); Morris Surgical; Home Health Equipment and Healthcare Equipment WA.

The acquisition of these Australian organisations has created a strong local business that has a broad product portfolio to support institutional and home healthcare.

Invacare Australia's current product range includes electric beds, furniture, static and active pressure care mattresses, patient lifters and slings, oxygen concentrators, manual and power wheelchairs, lightweight portable ramps, walking, toilet and bathroom aids.



Yes, you can.™

Invacare New Zealand

4 Westfield Place (PO Box 62-124) Mt Wellington Auckland, New Zealand  
Freephone: 0800 INVACARE (0800 468 222) Freefax: 0800 807 788  
Email: sales@invacare.co.nz Web: www.invacare.co.nz

Invacare Australia Pty Ltd

1 Lenton Place (PO Box 5002) North Rocks NSW 2151, Australia  
Freephone: 1800 460 460 Fax: 1800 814 367  
Email: sales@invacare.com.au Web: www.invacare.com.au

Invacare Asia Ltd

1 Lenton Place (PO Box 5002) North Rocks NSW 2151, Australia  
Phone: +61 2 8839 5330 Fax: +61 2 8839 5331  
Email: asiasales@invacare.com Web: www.invacare.com

All information is subject to change without prior notice. Photographs are for illustration purposes only and may vary from actual product.  
Invacare® is a registered trademark and Yes, you can.™ is a trademark of Invacare® Corporation. 2010 Invacare Asia Pacific.