

# The KSL

en **Active Wheelchair  
User Manual**



This manual **MUST** be given to the user of the product.  
**BEFORE** using this product, this manual **MUST** be read and saved for  
future reference.

**Küschall**<sup>®</sup>  
UNLIMIT YOUR WORLD

© 2021 Invacare Corporation

All rights reserved. Reproduction, duplication or modification in whole or in part is prohibited without prior written permission from Invacare. Trademarks are identified by ™ and ®. All trademarks are owned by or licensed to Invacare Corporation or its subsidiaries unless otherwise noted.

Making Life's Experiences Possible is a registered trademark in the U.S.A.

# Contents

---

<b>1 General</b>	<b>4</b>
1.1 Introduction	4
1.2 Symbols in this Document	4
1.3 Warranty Information	4
1.4 Compliance	5
1.4.1 Product-specific standards	5
1.5 Service Life	5
1.6 Limitation of Liability	5
<b>2 Safety</b>	<b>6</b>
2.1 Safety information	6
2.2 Labels and Symbols on the Product	9
<b>3 Product Overview</b>	<b>11</b>
3.1 Product description	11
3.2 Intended Use	11
3.3 Main parts of the wheelchair	12
3.4 Parking Brakes	12
3.5 Backrest	14
3.5.1 Push handles	16
3.6 Calf Strap	16
3.7 Seat cushion	17
<b>4 Options</b>	<b>18</b>
4.1 Anti-tipper	18
4.2 Posture belt	19
4.3 Air pump	20
4.4 Passive illumination	20
<b>5 Setup</b>	<b>21</b>
5.1 Safety information	21
<b>6 Usage</b>	<b>22</b>
6.1 Safety information	22

6.2 Braking During Use	22
6.3 Getting in and out of the wheelchair	23
6.4 Driving and Steering the Wheelchair	24
6.5 Negotiating steps and kerbs	25
6.6 Going up and down stairs	26
6.7 Negotiating ramps and slopes	27
6.8 Stability and balance when seated	29
6.9 Transporting the Mobility Device without Occupant	30
<b>7 Transport</b>	<b>31</b>
7.1 Safety information	31
7.2 Folding/Unfolding the backrest (optional)	31
7.3 Removing and Installing the Rear Wheels	32
<b>8 Maintenance</b>	<b>34</b>
8.1 Safety information	34
8.2 Maintenance Schedule	34
8.3 Cleaning and Disinfection	36
8.3.1 General Safety Information	36
8.3.2 Cleaning Intervals	37
8.3.3 Cleaning	37
8.3.4 Disinfection	37
<b>9 After Use</b>	<b>38</b>
9.1 Storage	38
9.2 Reconditioning	38
9.3 Disposal	38
<b>10 Troubleshooting</b>	<b>39</b>
10.1 Safety information	39
10.2 Identifying and repairing Faults	40
<b>11 Technical Data</b>	<b>42</b>
11.1 Dimensions and Weight	42
11.2 Tyres	43
11.3 Materials	44
11.4 Environmental conditions	44

# 1 General

## 1.1 Introduction

This user manual contains important information about the handling of the product. To ensure safety when using the product, read the user manual carefully and follow the safety instructions.

Note that there may be sections in this document, which are not relevant to your product, since this document applies to all available models (on the date of printing). If not otherwise stated, each section in this document refers to all models of the product.

The models and configurations available in your country can be found in the country-specific sales documents.

Invacare reserves the right to alter product specifications without further notice.

Before reading this document, make sure you have the latest version. You find the latest version as a PDF on the Invacare website.

If you find that the font size in the printed document is difficult to read, you can download the PDF version from the website. The PDF can then be scaled on screen to a font size that is more comfortable for you.

For more information about the product, for example product safety notices and product recalls, contact your Invacare distributor. See addresses at the end of this document.

In case of a serious incident with the product, you should inform the manufacturer and the competent authority in your country.

## 1.2 Symbols in this Document

Symbols and signal words are used in this document and apply to hazards or unsafe practices which could result in personal injury or property damage. See the information below for definitions of the signal words.



### WARNING

Indicates a hazardous situation that could result in serious injury or death if it is not avoided.



### CAUTION

Indicates a hazardous situation that could result in minor or slight injury if it is not avoided.



### IMPORTANT

Indicates a hazardous situation that could result in damage to property if it is not avoided.



### Tips and Recommendations

Gives useful tips, recommendations and information for efficient, trouble-free use.

## 1.3 Warranty Information

We provide a manufacturer's warranty for the product in accordance with our General Terms and Conditions of Business in the respective countries.

Warranty claims can only be made through the provider from whom the product was obtained.

## 1.4 Compliance

Quality is fundamental to the company's operation, working within the disciplines of ISO 13485.

This product features the CE mark, in compliance with the Medical Device Regulation 2017/745 Class I. The launch date of this product is stated in the CE declaration of conformity.

We are continuously working towards ensuring that the company's impact on the environment, locally and globally, is reduced to a minimum.

We only use REACH compliant materials and components.

### 1.4.1 Product-specific standards

The wheelchair has been tested in accordance with EN 12183. It includes testing for flammability.

For further information about local standards and regulations, contact your local Invacare representative. See addresses at the end of this document.

## 1.5 Service Life

The expected service life of this product is five years when used daily and in accordance with the safety instructions, maintenance intervals and correct use, stated in this manual. The effective service life can vary according to frequency and intensity of use.

## 1.6 Limitation of Liability

Invacare accepts no liability for damage arising from:

- Incorrect use
- Natural wear and tear
- Incorrect assembly or set-up by the purchaser or a third party
- Technical modifications
- Unauthorised modifications and/or use of unsuitable spare parts

- Non-compliance with the user manual

## 2 Safety

### 2.1 Safety information

This section contains important safety information for the protection of the wheelchair user and assistant and for safe, trouble-free use of the wheelchair.



**WARNING!**

**Risk of Serious Injury or Damage**

Improper use of this product may cause injury or damage.

- If you are unable to understand the warnings, cautions or instructions, contact a health care professional or provider before attempting to use this equipment.
- Do not use this product or any available optional equipment without first completely reading and understanding these instructions and any additional instructional material such as user manual, service manual or instruction sheet supplied with this product or optional equipment.



**WARNING!**

**Risk of death or serious injury**

In case of fire or smoke, wheelchair occupants are at particular risk of death or serious injury, when they are not able to move away from the source of fire or smoke. Lighted matches, lighter and cigarettes can cause an open flame in the wheelchair surroundings or on clothes.

- Avoid using or storing the wheelchair near open flames or combustible products.
- Do not smoke while using the wheelchair.



**WARNING!**

**Risk of accidents and serious injury**

Accidents with resulting serious injury can occur if the wheelchair is improperly adjusted.

- Wheelchair adjustments must always be carried out by a qualified technician.

**WARNING!****Risk of overturning**

The longitudinal position of the rear wheels axis of the wheelchair compared to the backrest position can affect its stability.

- A forwards position makes the wheelchair less stable and increase the risk of tipping backwards, but improves its maneuverability by a better grip position of the handrim and a short turning radius.
- Conversely, by moving the rear wheels axis backwards, the wheelchair is more stable and tilts less easily, but its maneuverability is reduced.
- Depending on the user's abilities and its particular safety limits, the decrease in stability can be compensated for by installing an anti-tipper device.

**WARNING!****Risk of tilting**

The position of the rear wheel axle and the angle of your wheelchair's backrest are two of the key adjustments that can affect your stability whilst sitting in the wheelchair.

- These changes, any front wheels position and/or angle fork adjustments to the set-up of your wheelchair must only be performed at the direction of a qualified technician who has fully risk assessed the implication of any changes to the wheelchair configuration. Therefore, consult with your authorized provider.

**WARNING!****Risk due to driving style being unsuitable for the conditions**

There is a risk of skidding on wet ground, gravel or uneven terrain.

- Always adjust your speed and driving style to the conditions (weather, surface, individual ability, etc.).

**WARNING!****Risk of injury**

In a collision you could sustain injury to parts of your body that extend beyond the wheelchair (e.g. feet or hands).

- Avoid an unbraked collision.
- Never drive into an object head-on.
- Drive carefully through narrow passages.

**WARNING!****Risk due to wheelchair being out of control**

At high speed you could lose control of your wheelchair and overturn.

- Always adjust your driving speed to the given conditions.
- Avoid collisions in general.



**WARNING!**

**Risk of accidents**

Safety devices that are incorrectly set or no longer working (brakes, anti tipper) can cause accidents.

- Always check that the safety devices are working before you use the wheelchair and have them regularly checked by a qualified technician or your provider.



**CAUTION!**

**Risk of injuries**

– In case of pressure sore or injured skin, protect your injury to avoid a direct contact with the fabrics of the device. Refer to a healthcare professional for medical advices.



**CAUTION!**

**Risk of injuries**

The use of a manual wheelchair can lead to shoulder pain. The following recommendations reduce this effect:

- Move the rear wheels further forwards so that the arms can move within the anatomical range.
- Make sure that the sits in an ergonomically seat position as the disability allows.



**CAUTION!**

**Risk of burning**

The wheelchair components can heat up when exposed to external sources of heat.

- Do not expose the wheelchair to strong sunlight before use.
- Before usage, check all components that come into contact with your skin for their temperature.



**CAUTION!**

**Risk of getting fingers caught**

There is always a risk of getting, e.g. fingers or arms, caught in the moving parts of the wheelchair.

- Make sure when activating the folding or insertion mechanisms of moving parts, such as the removable axle of the rear wheel, folding backrest or antitipper, that nothing becomes caught.



**CAUTION!**

**Risk of tipping**

The hanging of additional load (back pack or similar items) onto your chair backposts can affect the rearward stability of your wheelchair.

- Invacare strongly recommend the use of anti-tipper (available as an option) when using your backposts with additional load.



**CAUTION!****Risk of Injury**

Non-original or wrong parts may affect the function and safety of the product.

- Only use original parts for the product in use.
- Due to regional differences, refer to your local Invacare catalog or website for available options or contact your Invacare distributor. See addresses at the end of this document.

**IMPORTANT!**

When combining this product with another product, the restrictions of both products apply for the combination. E.g. the maximum user weight of one product in the combination may be lower.

- Only use combinations allowed by Invacare. Contact your Invacare distributor for information.
- Before use, read the user manual of each product and check the restrictions. The full compliance with the information, instructions and recommendations contained in both user manuals is necessary for a safe use.

**IMPORTANT!****Risk when using an add-on to support or substitute propelling the wheelchair**

For safety reasons, it must only be operated by persons who have the physical and mental ability to safely operate the wheelchair with the add-on attached to it in all possible situations (e.g. road traffic) and, in the event of the add-on failing to work or shutting down, are able to brake the wheelchair and stop safely. Any use contrary to the intended use involves a risk of injury.

At high speed you could lose control of your wheelchair and overturn.

- Drive carefully.
- Always adapt your speed and your driving style to the conditions (weather, surface, individual ability, etc.).
- Avoid collision.

An add-on to support or to substitute propelling the wheelchair increases the strain on the wheelchair structure.

- After each use of an add-on, check the wheelchair for frame cracks or loose screwing.
- If any sign of fatigue on the wheelchair structure, stop using the wheelchair immediately and contact a qualified technician.

## 2.2 Labels and Symbols on the Product

### Identification Label

The identification label is attached to the frame of your wheelchair and gives the following information:

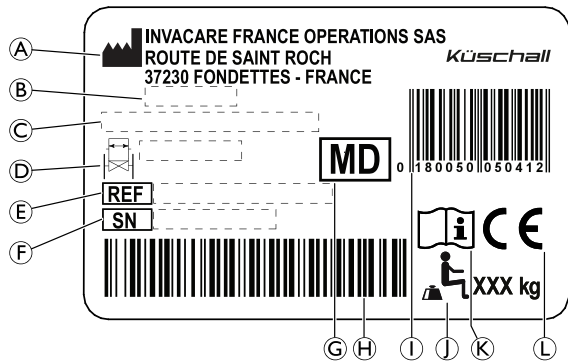

- Ⓐ Manufacturer's address
- Ⓑ Date of manufacture
- Ⓒ Product description
- Ⓓ Seat width
- Ⓔ Reference number
- Ⓕ Serial number
- Ⓖ Medical device
- Ⓗ Serial number barcode
- Ⓘ EAN/HMI barcode
- Ⓝ Maximum user weight
- Ⓚ Read user manual
- Ⓛ European conformity

## Snap Hook Symbol

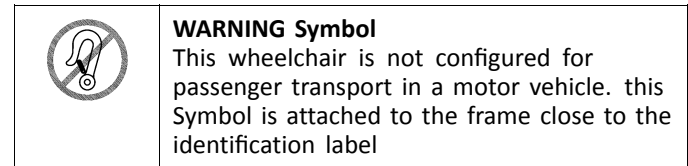

## Antitipper Warning Label

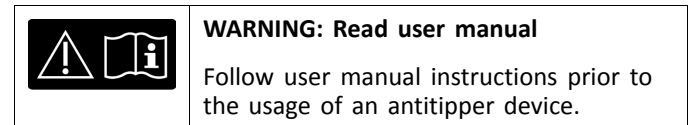

## Posture belt information label

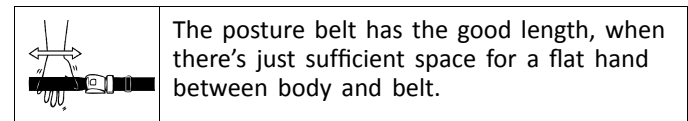

---

## 3 Product Overview

---

### 3.1 Product description

The KSL is a rigid frame active wheelchair.

#### ! IMPORTANT!

The wheelchair is manufactured and configured individually to the specifications in the order. The specification must be performed by a healthcare professional according to the user's requirements and health condition.

- Consult a healthcare professional if you intend to adapt the wheelchair configuration.
- Any adaptation must be performed by a qualified technician.

### 3.2 Intended Use

The wheelchair is intended to provide mobility to persons limited to a sitting position, who are propelling the wheelchair themselves most of the time.

The intended user is the wheelchair occupant and/or an assistant. The user should physically and mentally be able to use the wheelchair safely (e.g. to propel, steer, brake).

The wheelchair is intended for persons, ages 12 and up (adolescents and adults). The weight of the wheelchair occupant should not exceed the maximum user weight as stated in the Technical Data section and on the identification label.

The wheelchair is not intended for abusive or excessive activities, such as sports, that are not part of the intended (daily) use.

The wheelchair may be used indoors and outdoors on level ground and accessible terrain.

#### Indications

- Considerable to complete impairment of mobility due to structural and/or functional damage to the lower extremities.
- Sufficient strength and gripping function of arms and hands to propel the wheelchair.

There are no contraindications known, when using the wheelchair as intended.

### 3.3 Main parts of the wheelchair

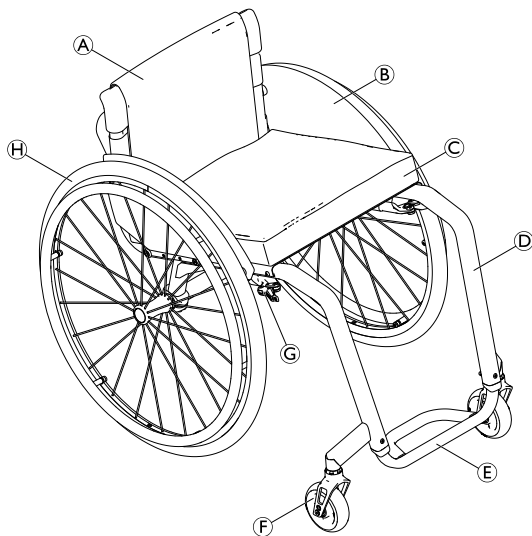

(A)	Backrest
(B)	Clothes-guard
(C)	Seat with cushion
(D)	Frame
(E)	Footrest
(F)	Castor fork with castor wheel
(G)	Parking brake
(H)	Rear wheel with handrim and quick-release axle

 The equipment of your wheelchair may differ from the image as each wheelchair is manufactured individually to the specifications in the order.

### 3.4 Parking Brakes

The parking brakes are used to immobilise the wheelchair when it is stationary to prevent it from rolling away.



#### **WARNING!**

#### **Risk of Overturning if you brake sharply**

If you engage the parking brakes while you are moving, the direction of movement can become uncontrollable and the wheelchair may stop suddenly, which can lead to a collision or to you falling out.

– Never engage the parking brakes while you are moving.



**WARNING!**

**Risk due to wheelchair being out of control**

- The parking brakes must be operated simultaneously.
- Do not engage the parking brakes to slow down the wheelchair.
- Do not lean on the parking brakes for support or transfer.



**WARNING!**

**Risk of Overturning**

- The parking brakes will not operate correctly unless there is sufficient air pressure in the tyres.
- Ensure the correct tyre pressure, see 11.2 Tyres, page 43.



**CAUTION!**

**Risk of pinching or crushing**

Do not grasp the brake mechanism with the full hand when engage or disengage the brake.



The distance between the brake shoe and the tire can be adjusted. The adjustment must be carried out by a qualified technician.

**Standard Brake**

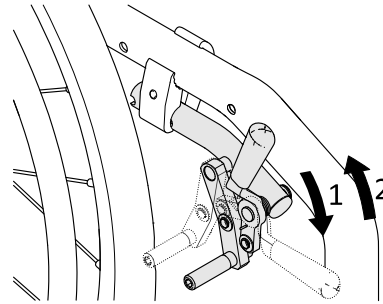

1. To engage the brake, push the brake lever forwards with the palm as far as possible.
2. To disengage the brake, pull the brake lever backwards with the low fingers.

**Performance Brake**

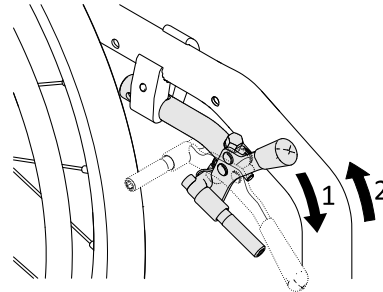

1. To engage the brake, push the brake lever forwards with the palm as far as possible.
2. To disengage the brake, pull the brake lever backwards with the low fingers.

### Active Brake

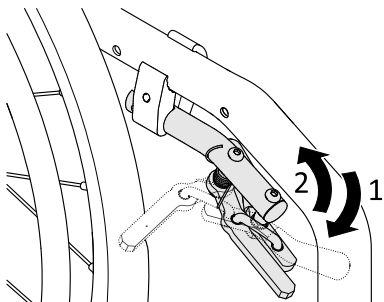

1. To engage the brake, pull the brake lever forwards beside or between your knees as far as possible.
2. To disengage the brake, push the brake lever backwards beside or between your knees.

### Light active Brake

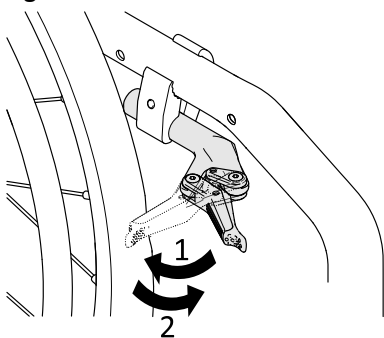

#### **CAUTION!**

##### **Risk of pinching or crushing**

Do not grasp the brake mechanism with the full hand when engage or disengage the brake.

1. To engage the brake, pull the brake lever backwards with the palm against the tyre as far as possible.
2. To disengage the brake, push the brake lever forwards with the hand edge.

### 3.5 Backrest



#### **WARNING!**

##### **Risk of injury to the assistant and damage to the wheelchair**

Tilting the chair with a heavy user can hurt the assistant's back and damage the chair.

- Make sure to be able to safely control the wheelchair with a heavy user before performing a tilting maneuver.

#### **Standard Backrest Cover**



A standard backrest cover is available for all backrest types. These covers are not adjustable.



#### **WARNING!**

##### **Risk of tipping**

If the standard backrest cover become slack, the tipping point of your wheelchair is changed for the worse.

- Slack standard backrest cover must be replaced by a qualified technician.

In addition to the standard backrest cover, there are tension-adjustable backrest covers available.

### Adjusting the Tension of the Backrest Cover

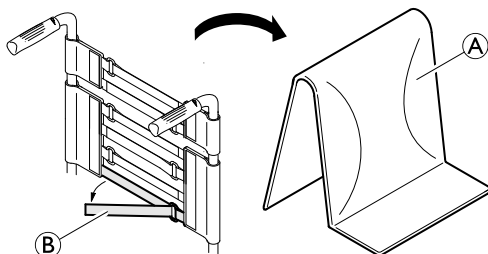

1. Remove the backrest cushion **A**.
2. Loosen the hook-and-loop straps **B** on the rear of the backrest cover by simply pulling on them.
3. Tighten or loosen the bands as required then reattach them.



#### **WARNING!** **Risk of Tipping**

If the bands are set very loose, the tipping point of your wheelchair is changed for the worse.  
– Ensure that the bands are set correctly.



#### **IMPORTANT!**

There is a risk that the geometry of the wheelchair is changed when the bands are overtightened.  
– Do not overtighten the bands.

### Backrest Height / Backrest Angle

The height and the angle of the backrest can be adjusted. The adjustment must be carried out by a qualified technician.



#### **WARNING!** **Risk of tipping**

The hanging of additional load (back pack or similar items) onto your wheelchair back posts can affect the rearward stability of your wheelchair. This can cause the chair to tip backwards causing injury.

- Therefore, Küschall strongly recommend the use of anti-tippers (available as an option) when using your back posts with additional load (back pack or similar items).

### Backrest Bar



#### **WARNING!** **Risk of Accidents**

The backrest bar is not suited for lifting or carrying the wheelchair with the user sitting in it as it can break.

- The backrest bar may not be used to lift or carry the wheelchair while the user is sitting in it.

### 3.5.1 Push handles



#### IMPORTANT!

- Always check the push handles before using the wheelchair, as to whether the hand grips are secure, cannot be turned and cannot be pulled off.

#### Foldable push handles

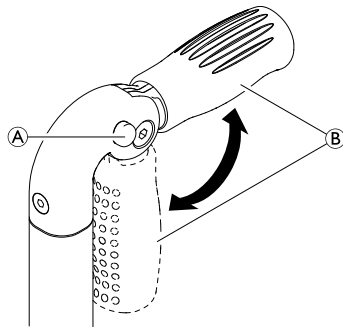

1. Fully depress button (A) and fold up respectively fold down the push handle (B) until it audibly engages.



#### CAUTION!

- If not correctly engaged, the push handle could accidentally fold down while pushing the wheelchair.
- Make sure that the push handle is correctly engaged.

#### Height-adjustable push handles

The stepless height-adjustable push handles allow any assistant to adjust the handles to a comfortable level.

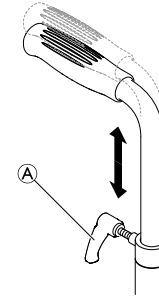

1. To set the height of the push handles, loosen the bolt (A), push the handle to the desired position and tighten the bolt again.



#### WARNING!

##### Risk of injury

- Do not use the height-adjustable push handles to pull the wheelchair.

### 3.6 Calf Strap

A calf strap is installed to the wheelchair to provide a better position of the users' legs.



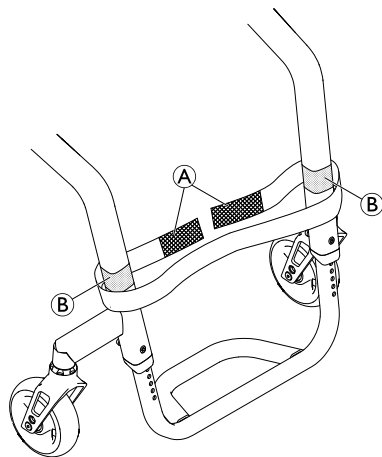

### Installing/adjusting the Calf Strap

1. Install and adjust the calf strap **A** around the hook and loop fasteners **B** on both frame parts.

## 3.7 Seat cushion

A suitable cushion is needed to provide an even pressure distribution on the seat.



### CAUTION!

#### Risk of instability

Adding a cushion to the seat will raise your height above the ground and can affect your stability in all directions. If a cushion is changed it may also change the user's stability.

- If the thickness of the cushion is changed, a complete set up of the wheelchair need to be done by a qualified technician.



Use a seat cushion with anti-slip underlay or hook fastening tapes to avoid slipping of the seat cushion. A loop fastening tape is pre-attached to the seat cover.

## 4 Options

### 4.1 Anti-tipper

An anti-tipper prevents the wheelchair from tipping backwards.



#### **WARNING!**

##### **Risk of overturning**

Anti-tippers that are incorrectly set or no longer working can lead to overturning.

- Always check that the anti-tipper is working before using the wheelchair and have it set or readjusted by a qualified technician when required.



#### **WARNING!**

##### **Risk of overturning**

On uneven or soft ground, the anti-tipper can sink into potholes or directly into the ground, thereby curtailing or eliminating its safety function.

- Only use the anti-tipper when travelling on even and firm ground.



#### **IMPORTANT!**

##### **Risk of damage**

- Never step on the anti-tipper or use it as a tipping aid.

### Activating the anti-tipper

1. Push the anti-tipper completely downwards against the spring and swivel it backwards through 90° until it engages.



#### **WARNING!**

##### **Risk of tipping**

If the wheelchair is equipped with a retractable anti-tipper, it must always remain in the active position for user safety.

- It can be temporarily deactivated to overcome an obstacle that it cannot pass if it is in an active position.
- Never leave a user alone in their wheelchair with the anti-tipper device deactivated.

### Deactivating the anti-tipper

1. Push the anti-tipper completely downwards against the spring and swivel it inwards through 90° until it engages.

### Setting the position

1. Press the spring pin  on the anti-tipper and push the inner section to the position required. Allow the spring pin to engage in the nearest hole.



If further adjustments of height and/or position are necessary, refer to a qualified technician.

## 4.2 Posture belt

The wheelchair can be equipped with a posture belt. It prevents the user from sliding downward in the wheelchair or from falling out of the wheelchair. The posture belt is not a positioning device.



### WARNING!

#### Risk of serious injury / strangulation

A loose belt can allow the user to slip down and create a risk of strangulation.

- The posture belt should be mounted by a qualified technician and fitted by the responsible prescriber.
- Always make sure that the posture belt is tightly fitted across the lower pelvis.
- Each time the posture belt is used, check if it fits properly. Changing the seat and/or backrest angle, the cushion and even your clothes influence the fit of the belt.

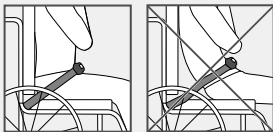

## Closing and opening the posture belt

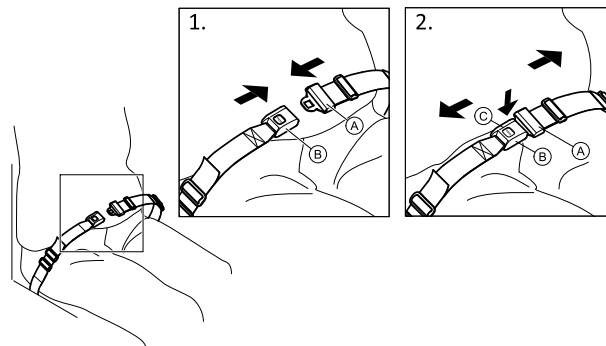

Ensure that you are sitting fully back in the seat and that the pelvis is as upright and symmetrical as possible.

1. To close, push the catch **A** into the buckle clasp **B**.
2. To open, push the PRESS button **C** and pull the catch **A** out of the buckle clasp **B**.

## Adjusting the length



The posture belt has the good length, when there's just sufficient space for a flat hand between body and belt.

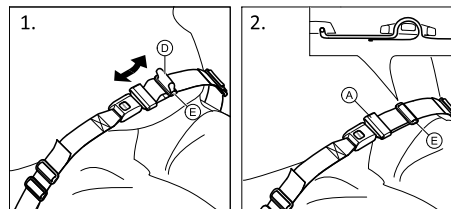

1. Shorten or extend the loop ④ as required.
2. Thread loop ④ through catch ① and plastic buckle ⑤ until the loop is flat.

If this adjustment is not sufficient, it might be required to re-fit the posture belt at the fixations.

#### Fitting the posture belt at the fixations



#### CAUTION!

- Thread the belt loop through both plastic buckles to avoid the belt from loosening.
- Do the adjustments on both sides equally, so that the buckle clasp remains in a central position.
- Make sure that the belts do not get caught in the spokes of a rear wheel.

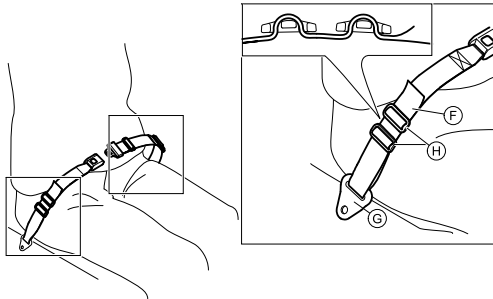

1. Thread the loop ⑥ through the fixation on the chair ③ and then through BOTH plastic buckles ④.

### 4.3 Air pump

The air pump is fitted with a universal valve connection.

1. Remove the dust cap from the valve connection.
2. Push the valve connection onto the open valve on the wheel and pump the wheel up.

### 4.4 Passive illumination

You can attach reflectors to the rear wheels.

---

## 5 Setup

---

### 5.1 Safety information

**CAUTION!****Risk of injury**

- Before using the wheelchair, check its general condition and its main functions, 8.2 *Maintenance Schedule, page 34.*

Your provider will supply your wheelchair ready for use. Your provider will explain the main functions and ensure that the wheelchair meets your needs and requirements.

Adjustments of the axle position and the castor supporters must be carried out by a qualified technician.

## 6 Usage

### 6.1 Safety information



**WARNING!**

**Risk of accidents**

Uneven tyre pressure can have a huge effect on handling.

- Check the tyre pressure before each journey.



**WARNING!**

**Risk of falling out of the wheelchair**

When using too small front wheels the wheelchair could get stuck at curbs or in floor grooves.

- Make sure that the front wheels are suitable for the surface you're driving on.



**CAUTION!**

**Risk of crushing**

There may be a very small gap between the rear wheel and the mudguard or armpad with the risk that you could trap your fingers.

- Ensure that you always propel your wheelchair using the handrims only.



**CAUTION!**

**Risk of crushing**

There may be a very small gap between the rear wheel and the parking brake with the risk that you could trap your fingers.

- Ensure that you always propel your wheelchair using the handrims only.

### 6.2 Braking During Use

Whilst you are moving, you brake by transferring force to the handrim with your hands.



**WARNING!**

**Risk of overturning**

If you apply the parking brakes while you are moving, the direction of movement can become uncontrollable and the wheelchair may stop suddenly, which can lead to a collision or to you falling out.

- Never apply the parking brakes while you are moving.



**WARNING!**

**Risk of falling out of the wheelchair**

If the wheelchair is rapidly decelerated by an assistant pulling at the push handles, the user may fall out of the wheelchair.

- Always apply the posture belt if present.
- Make sure your assistant is qualified in transferring occupied wheelchairs.

**CAUTION!****Risk of burning your hands**

If you brake for a long time, a lot of frictional heat is produced at the handrims.

- Wear suitable gloves.

1. Hold the handrims and press evenly with both hands until the wheelchair stops.

### 6.3 Getting in and out of the wheelchair

**WARNING!****Risk of overturning**

There is a high risk of overturning during the transfer.

- Only get in and out without assistance if you are physically able to do so.
- When transferring, position yourself as far back as possible in the seat. This will prevent damaged upholstery and the possibility of the wheelchair tipping forward.
- Make sure that both castors are facing straight to the front.

**WARNING!****Risk of overturning**

The wheelchair could tip forwards if you stand on the footrest.

- Never stand on the footrest when getting in and out.

**CAUTION!**

If you release or damage the brakes the wheelchair could roll away out of control.

- Do not support yourself on the brakes when getting in and out.

**IMPORTANT!**

The mudguards and armrests could become damaged.

- Never sit on the mudguards or armrests when getting in and out.



1. Propel the wheelchair as near as possible to the seat that you want to move to.
2. Apply the parking brakes.
3. Remove the armrests or move them upwards out of the way.
4. Place your feet on the ground.
5. Hold the wheelchair and, if necessary, also hold a fixed object in the vicinity.
6. Move slowly to chair.

## 6.4 Driving and Steering the Wheelchair

You drive and steer the wheelchair using the handrims. Before driving without an assistant you must find your wheelchair's tipping point.



### **WARNING!**

#### **Risk of Tipping**

The wheelchair can tip backwards if it is not fitted with an antitipper. When finding the tipping point, an assistant must stand immediately behind the wheelchair to catch it if it tips over.

- To prevent tipping, install an antitipper device.



### **WARNING!**

#### **Risk of Tipping**

The wheelchair can tip forwards.

- When setting up your wheelchair, test its behavior in terms of tipping forward and adjust your driving style accordingly.



### **CAUTION!**

A heavy load hanging on the backrest can affect the wheelchair's centre of gravity.

- Change your driving style accordingly.

## Finding the Tipping Point

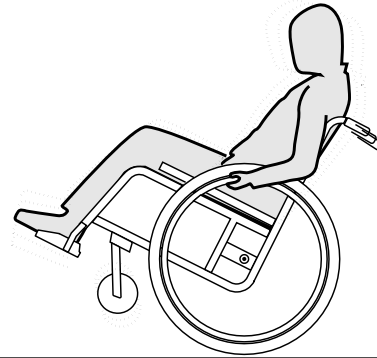

1. Release the brake.
2. Roll backwards a short distance, grasp both handrims firmly and push forwards with a slight kick.
3. The shift in weight and steering in opposite directions with the handrims will enable you to identify the tipping point.



## 6.5 Negotiating steps and kerbs



### WARNING!

#### Risk of overturning

When negotiating steps you could lose your balance and tip the wheelchair over.

- Always approach steps and kerbs slowly and carefully.
- Do not go up or down steps that are higher than 25 cm.



### CAUTION!

An activated anti-tipper prevents the wheelchair from tipping backwards.

- Deactivate the anti-tipper before going up or down steps or kerbs.



### WARNING!

#### Risk of injury to the assistant and damage to the wheelchair

Tilting the chair with a heavy user can hurt the assistant's back and damage the chair.

- Make sure to be able to safely control the wheelchair with a heavy user before performing a tilting maneuver.

## Going down a step with an assistant

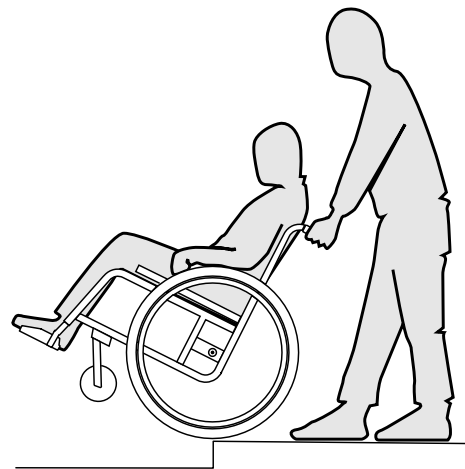

1. Move the wheelchair right up to the kerb and hold the handrims.
2. The assistant should hold both push handles, place one foot on the tipper aid (if installed) and tilt the wheelchair backwards so that the front wheels lift off the ground.
3. The assistant should then hold the wheelchair in this position, push it carefully down the step and then tilt it forwards until the front wheels are back on the ground.

## Going up a step with an assistant



### **WARNING!**

#### **Risk of serious injuries**

Going up steps and kerbs frequently can result in earlier than expected fatigue break of the wheelchair backrest. The user might fall out of the wheelchair.

– Always use a tipper aid when going up steps or kerbs.

1. Move the wheelchair backwards until the rear wheels touch the kerb.
2. The assistant should tilt the wheelchair using both push handles so that the front wheels lift off the ground, then pull the rear wheels over the kerb until the front wheels can be placed back on the ground.

## Going down a step without an assistant

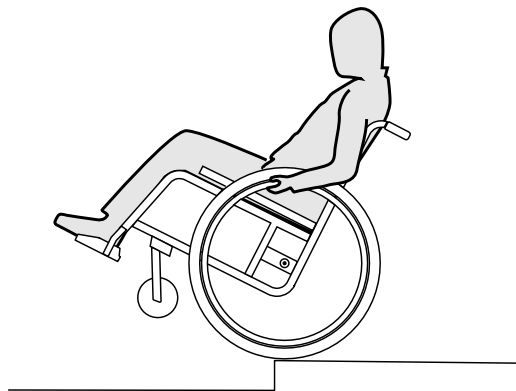

### **WARNING!**

#### **Risk of tipping**

When going down a step without an assistant you could tip over backwards if you cannot control your wheelchair.

- First learn how to go down a step with an assistant.
- Learn how to balance on the rear wheels, *6.4 Driving and Steering the Wheelchair, page 24.*

1. Move the wheelchair right to the kerb, lift the front wheels and keep the wheelchair balanced.
2. Now slowly roll both rear wheels over the kerb. While doing this, hold the handrims firmly with both hands until the front wheels are back on the ground.

## 6.6 Going up and down stairs



### **WARNING!**

#### **Risk of overturning**

When negotiating stairs you could lose your balance and overturn your wheelchair.

- Always use two assistants when negotiating stairs with more than one step.



1. You can go up and down stairs by taking them one step at a time, as described above. The first assistant should stand behind the wheelchair holding the push handles. The second assistant should hold a solid part of the front frame to steady the wheelchair from the front.

## 6.7 Negotiating ramps and slopes



### WARNING!

#### Risk due to wheelchair being out of control

When negotiating slopes or gradients your wheelchair could tip backwards, forwards or sideways.

- Always have an assistant behind the wheelchair when approaching long slopes.
- Avoid lateral slopes.
- Avoid slopes of more than 7°.
- Avoid jerking when changing direction on a slope.



### CAUTION!

Your wheelchair could run away even on slightly sloping ground if you do not control it using the handrims.

- Use the parking brakes if your wheelchair is stationary on sloping ground.

### Going up slopes

To go up a slope, you must create some momentum, keep up the momentum and control the direction at the same time.

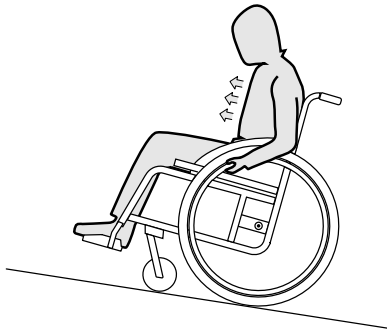

1. Bend your upper body forwards and propel the wheelchair with quick, powerful strokes on both handrims.

### Going down slopes

When going down slopes, it is important to control your direction and particularly your speed.

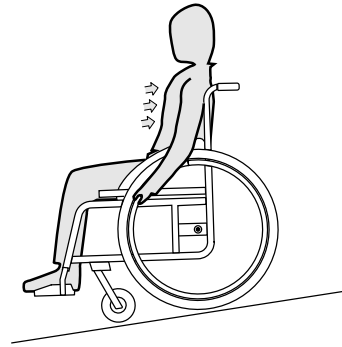

1. Lean back and carefully allow the handrims to run through your hands. You should be able to stop the wheelchair at any time by gripping the handrims.



### **CAUTION!**

#### **Risk of burning your hands.**

If you brake for a long time, a lot of frictional heat is produced at the handrims.

– Wear suitable gloves.

## 6.8 Stability and balance when seated

Some everyday activities and actions require you to lean forwards, sideways or backwards out of the wheelchair. This has a major effect on the wheelchair's stability. To keep your balance at all times, proceed as follows:

### Leaning forwards



#### **WARNING!** **Risk of falling out**

If you lean forwards out of the wheelchair you could fall out of it.

- Never bend too far forwards and do not shift forwards in your seat to reach an object.
- Do not bend forwards between your knees to pick up something off the floor.

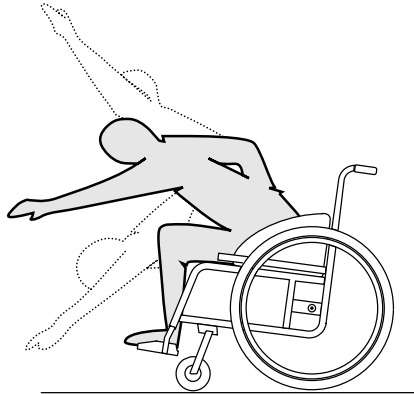

1. Point the front wheels forwards. (To do this, move your wheelchair forwards slightly then back again.)
2. Apply both parking brakes.
3. When leaning forwards your upper body must remain over the front wheels.

### Reaching backwards



#### **WARNING!** **Risk of falling out**

If you lean too far backwards you could tip your wheelchair over.

- Do not lean out over the backrest.
- Use an antitipper device.

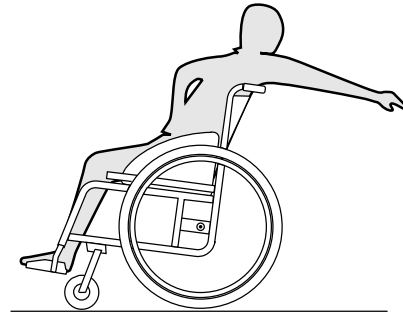

1. Point the front wheels forwards. (To do this, move your wheelchair forwards slightly then back again.)
2. Do not apply the parking brakes.
3. When reaching backwards do not reach so far that you have to change your sitting position.

## 6.9 Transporting the Mobility Device without Occupant



### **CAUTION!**

#### **Risk of injury**

- If you are unable to fasten your mobility device securely in a transport vehicle, Invacare recommends that you do not transport it.

Your mobility device may be transported without restrictions, whether by road, rail or by air. Individual transport companies have, however, guidelines which can possibly restrict or forbid certain transport procedures. Please ask the transport company regarding each individual case.

- Invacare strongly recommends securing the mobility device to the floor of the transporting vehicle.

## 7 Transport

### 7.1 Safety information



**WARNING!**

**Risk of injury if wheelchair is not secured during transport**

Your wheelchair is not designed for passenger transport in vehicles. You could suffer serious injury in an accident.

- During transport, sit in a correctly secured seat, not in the wheelchair.



**WARNING!**

**Risk of injury if the wheelchair is not properly secured**

In the event of an accident, braking manoeuvre, etc. you may suffer serious injuries from flying wheelchair parts.

- Always remove the rear wheels when transporting the wheelchair.
- Firmly secure all wheelchair components in the means of transport to prevent them from coming loose during the journey.
- When transporting the unoccupied wheelchair in a car or an airplane make sure that it is folded and secured.



**IMPORTANT!**

Excessive wear and abrasion could affect the strength of load-bearing parts.

- Do not pull your wheelchair across abrasive surfaces without the wheels fitted (e.g. pulling the frame over tarmac).

### 7.2 Folding/Unfolding the backrest (optional)

#### Folding the backrest

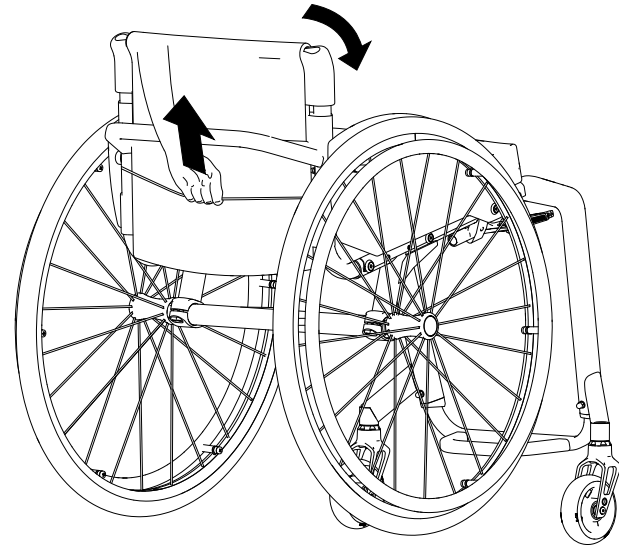

1. To fold down the back, grip the strap on the back of the wheelchair and pull it upwards.
2. At the same time, push the upper edge of the backrest forwards.

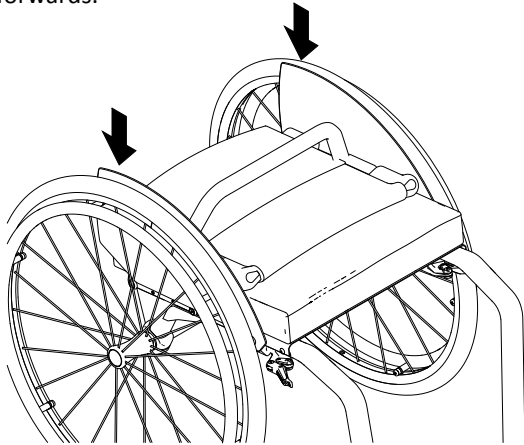

3. Push down both side parts (mudguard or clothes-guard) completely so that the backrest remains fixed in the fold down position.
4. The wheelchair can now be lifted using the backrest bar.



If a mudguard is fitted, the rear wheels must be pulled outwards or removed before the mudguard can be lowered completely.

### Unfolding the backrest

1. To straighten up the backrest, grip the strap on the back of the wheelchair and pull it upwards.
2. At the same time, grip the upper edge of the backrest and straighten it up.

3. Push the side parts down until they engage.
4. Put the rear wheels back on if you removed them.

## 7.3 Removing and Installing the Rear Wheels



### WARNING!

#### Risk of Overturning

If the removable axle of a rear wheel is not fully engaged, the wheel can become loose during use. This can lead to overturning.

- Always ensure that the removable axles are fully engaged whenever you fit a wheel.

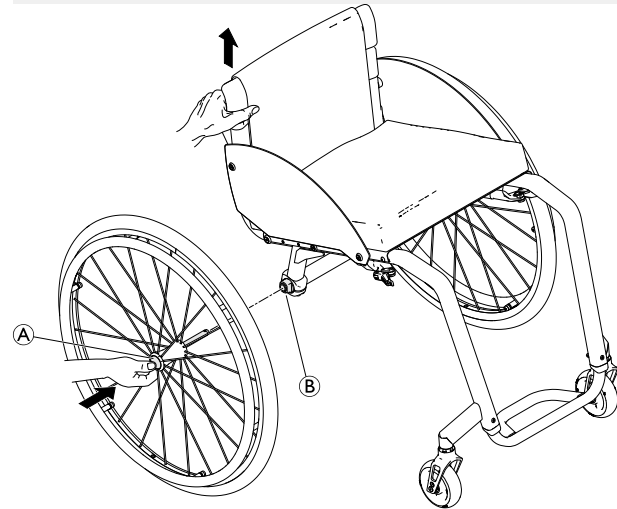

### Removing the Rear Wheels

1. Disengage the wheel locks.
2. With one hand, hold the wheelchair upright.



3. With the other, hold the wheel through the external spoke rim around the wheel hub.
4. Using your thumb, press the removable axle button **(A)**. Keep it pressed and pull the wheel out of the adapter sleeve **(B)**.

### **Installing the Rear Wheels**

1. Disengage the wheel locks.
2. With one hand, hold the wheelchair upright.
3. With the other, hold the wheel through the external spoke rim around the wheel hub.
4. Using your thumb, press the removable axle button **(A)** and hold it down.
5. Push the axle into the adapter sleeve **(B)** up to the stop.
6. Release the removable axle button and make sure that the wheel is secure.

## 8 Maintenance

### 8.1 Safety information



#### **WARNING!**

Some materials deteriorate naturally over time. This could result in damage to wheelchair components.

- Your wheelchair should be checked by a qualified technician at least once a year or if it has not been used for a long period.



#### Packaging for return

The wheelchair shall be sent to the authorized provider in an appropriate packaging to avoid damage during the shipment.

### 8.2 Maintenance Schedule

To ensure safe and reliable operation, carry out the following visual checks and maintenance regularly or have it carried out by another person.

	<b>weekly</b>	<b>monthly</b>	<b>annually</b>
Check the tyre pressure	x		
Check that rear wheels are seated correctly	x		
Check posture belt	x		

	<b>weekly</b>	<b>monthly</b>	<b>annually</b>
Check the folding mechanism		x	
Check the castors		x	
Check bolts		x	
Check spokes		x	
Check parking brakes		x	
Have wheelchair checked by a qualified technician			x

#### **General visual check**

1. Examine your wheelchair for loose parts, cracks or other defects.
2. If you find anything, stop using your wheelchair immediately and contact an authorized provider.

#### **Check the tyre pressure**

1. Check the tyre pressure, see section “Tyres” for more information.
2. Inflate the tyres to the required pressure.
3. Check the tyre tread at the same time.
4. If necessary, change the tyres.

### Check that rear wheels are seated correctly

1. Pull on the rear wheel to check that the removable axle is seated correctly. The wheel should not come off.
2. If the rear wheels are not engaged properly, remove any dirt or deposits. If the problem persists, have the removable axles re-fitted by a qualified technician.

### Check posture belt

1. Check that the posture belt is adjusted correctly.



#### IMPORTANT!

- Loose posture belts must be adjusted by an authorized provider.
- Damaged posture belts must be replaced by a qualified technician.

### Check the folding mechanism

1. Check that the folding mechanism is easy operating.

### Check the castors

1. Check that the castors turn freely.
2. Remove any dirt or hair from the castor bearings.
3. Faulty or worn out castors must be replaced by a qualified technician.

### Check the bolts

Bolts can work loose through constant use.

1. Check that the bolts are tight securely and without free play (on the footrest, castor, castor housing, seat cover, sides, backrest, frame, seat module).
2. Tighten any loose bolts with the suitable torque. Therefore refer to the Service Manual, available on the internet at [www.invacare.eu.com](http://www.invacare.eu.com).



#### IMPORTANT!

- Self-locking screws/nuts or thread-locking adhesive are used for several connections. If these are loosened, they must be replaced by new self-locking screws/nuts or they must be secured using new thread-locking adhesive.
- Self-locking screws/nuts must be replaced by a qualified technician.

### Check the spoke tension

The spokes should not be loose or distorted.

1. Loose spokes must be tightened by a qualified technician.
2. Broken spokes must be replaced by a qualified technician.

### Check the parking brakes

1. Check that the parking brakes are positioned correctly. The brake is set correctly if the brake shoe depresses the tyre by a few millimeters when the brake is engaged.
2. If you find that the setting is not correct, have the brakes correctly adjusted by a qualified technician.

**!** **IMPORTANT!**

The parking brakes must be reset after replacing the rear wheels or changing their position.

### Checking after a heavy collision or blow

**!** **IMPORTANT!**

The wheelchair can sustain visibly undetectable damage as a result of a heavy collision or hard blow.

- It is essential to have your wheelchair checked by a qualified technician after a heavy collision or hard blow.

### Repairing or changing an inner tube

1. Remove the rear wheel and release any air from the inner tube.
2. Lift one tyre wall away from the rim using a bicycle tyre lever. Do not use sharp objects such as a screwdriver which could damage the inner tube.
3. Pull the inner tube out of the tyre.
4. Repair the inner tube using a bicycle repair kit or, if necessary, replace the tube.
5. Inflate the tube slightly until it becomes round.
6. Insert the valve into the valve hole on the rim and place the tube inside the tyre (the tube should lie right round the tyre with no creases).
7. Lift the tyre wall over the edge of the rim. Start close to the valve and use a bicycle tyre lever. When doing this, check all the way round to ensure that the inner tube is not trapped between the tyre and the rim.
8. Inflate the tyre to the maximum operating pressure. Check that no air is escaping from the tyre.

### Spare parts



All spare parts may be obtained from an Invacare authorized provider.

## 8.3 Cleaning and Disinfection

### 8.3.1 General Safety Information



**CAUTION!**

**Risk of Contamination**

- Take precautions for yourself and use appropriate protective equipment.



**IMPORTANT!**

Wrong fluids or methods can harm or damage the product.

- All cleaning agents and disinfectants used must be effective, compatible with one another and must protect the materials they are used to clean.
- Never use corrosive fluids (alkalines, acid etc.) or abrasive cleaning agents. We recommend an ordinary household cleaning agent such as dishwashing liquid, if not specified otherwise in the cleaning instructions.
- Never use a solvent (cellulose thinner, acetone etc.) that changes the structure of the plastic or dissolves the attached labels.
- Always make sure that the product is completely dried before taking it into use again.

 For cleaning and disinfection in clinical or long-term care environments, follow your in-house procedures.

### 8.3.2 Cleaning Intervals



#### **IMPORTANT!**

Regular cleaning and disinfection enhances smooth operation, increases the service life and prevents contamination.

Clean and disinfect the product

- regularly while it is in use,
- before and after any service procedure,
- when it has been in contact with any body fluids,
- before using it for a new user.

### 8.3.3 Cleaning



#### **IMPORTANT!**

- The product does not tolerate cleaning in automatic washing plants, with high-pressure cleaning equipment or steam.



#### **IMPORTANT!**

Dirt, sand and seawater can damage the bearings and steel parts can rust if the surface is damaged.

- Only expose the wheelchair to sand and seawater for short periods and clean it after every trip to the beach.
- If the wheelchair is dirty, wipe off the dirt as soon as possible with a damp cloth and dry it carefully.

1. Remove any installed optional equipment (only optional equipment which does not require tools).
2. Wipe down the individual parts using a cloth or soft brush, ordinary household cleaning agents (pH = 6 - 8) and warm water.
3. Rinse the parts with warm water.
4. Thoroughly dry the parts with a dry cloth.



Car polish and soft wax can be used on painted metal surfaces to remove abrasions and restore gloss.

### Cleaning upholstery

For cleaning upholstery refer to the instructions on the labels of the seat, cushion and backrest cover.



If possible, always overlap hook and loop strips (the self-gripping parts) when washing, to minimize lint and thread build-up on hook strips and prevent damage to upholstery fabric by these.

### 8.3.4 Disinfection

The wheelchair may be disinfected by spraying or wiping with tested, approved disinfectants.



Spray a soft cleaning and disinfecting product (bactericidal and fungicide meeting the EN1040 / EN1276 / EN1650 standards) and follow the instructions given by the manufacturer.

1. Wipe down all generally accessible surfaces with a soft cloth and ordinary household disinfectant.
2. Allow the product to air-dry.

## 9 After Use

### 9.1 Storage



#### **IMPORTANT!**

Risk of damage to the product

- Do not store the product near heat sources.
- Never store other items on top of the wheelchair.
- Store the wheelchair indoors in a dry environment.
- Refer to temperature limitation in chapter 11 *Technical Data, page 42.*

After long-term storage (more than four months) the wheelchair must be inspected in accordance to chapter 8 *Maintenance, page 34.*

### 9.2 Reconditioning

This product is suitable for reuse. To recondition the product for a new user, carry out the following actions:

- Inspection
- Cleaning and disinfection
- Adaptation to the new user

For detailed information, see 8 *Maintenance, page 34* and the service manual for this product.

Make sure that the user manual is handed over with the product.

If any damage or malfunction is detected, do not reuse the product.

### 9.3 Disposal

Be environmentally responsible and recycle this product through your recycling facility at its end of life.

Disassemble the product and its components, so the different materials can be separated and recycled individually.

The disposal and recycling of used products and packaging must comply with the laws and regulations for waste handling in each country. Contact your local waste management company for information.

---

## 10 Troubleshooting

---

### 10.1 Safety information

Faults may arise as a result of daily use, adjustments or changing demands on the wheelchair. The table below shows how to identify and repair faults.

Some of the actions listed must be carried out by a qualified technician. These are indicated. We recommend that *all* adjustments are carried out by a qualified technician.

**CAUTION!**

– If you notice a fault with your wheelchair, e.g. a significant change in handling, stop using your wheelchair immediately and contact your provider.

## 10.2 Identifying and repairing Faults

Fault	Possible Cause	Action
The wheelchair does not travel in a straight line	Incorrect tyre pressure on one rear wheel	Correct tyre pressure, → <i>11.2 Tyres, page 43</i>
	One or more spokes broken	Replace faulty spoke(s), → qualified technician
	Spokes tightened unevenly	Tighten loose spokes, → qualified technician
	Castor supporter is not aligned correctly	Correct position and alignment of the castor supporter, → qualified technician
	Castor bearings are dirty or damaged	Clean or replace the bearings, → qualified technician
	Rear wheels are off track	Change track, → qualified technician
	Castors not adjusted to same height	Position the castors such that they touch the floor at the same time, → qualified technician
The wheelchair tips backwards too easily	Rear wheels are mounted too far forwards	Mount the rear wheels further back, → qualified technician
Removable axles cannot be inserted correctly	Back angle too large	Reduce the backrest angle, → qualified technician
	Removable axles dirty	Clean removable axles
The parking brakes are gripping poorly or asymmetrically	Removable axles misaligned	Adjust removable axles, → qualified technician
	Incorrect tyre pressure in one or both rear tyres	Correct tyre pressure, → <i>11.2 Tyres, page 43</i>
	Parking brake setting incorrect	Correct the parking brake setting, → qualified technician



Fault	Possible Cause	Action
Rolling resistance is very high	Tyre pressure in rear tyres is too low Tyre is punctured	Correct tyre pressure or replace the tube inside the tyre, → <i>11.2 Tyres, page 43</i>
	Rear wheels not parallel	Ensure the rear wheels are parallel, → qualified technician
The castors wobble when moving fast	Too little tension in castor bearing block	Tighten the nut on the bearing block axle slightly, → qualified technician
	Castor wheel has worn smooth	Change castor, → qualified technician
The castor is stiff or stuck	Bearings are dirty or faulty	Clean or replace the bearings, → qualified technician
The backrest is very difficult to unfold	Backrest cover is too tight	Loosen the hook-and-loop straps of the backrest cover a little, → <i>3.5 Backrest, page 14</i>

## 11 Technical Data

### 11.1 Dimensions and Weight

All dimension and weight specifications refer to a wide range of the wheelchair in a standard configuration. Dimension and weight (based on ISO 7176-1/5/7) may alter according to different configurations.



#### IMPORTANT!

- In some configurations, the overall dimensions of the wheelchair when it is ready for use exceeds the authorised limits and the access to emergency escape routes is not possible.
- In some configurations, the wheelchair exceeds the size recommended for travelling by train in the EU.

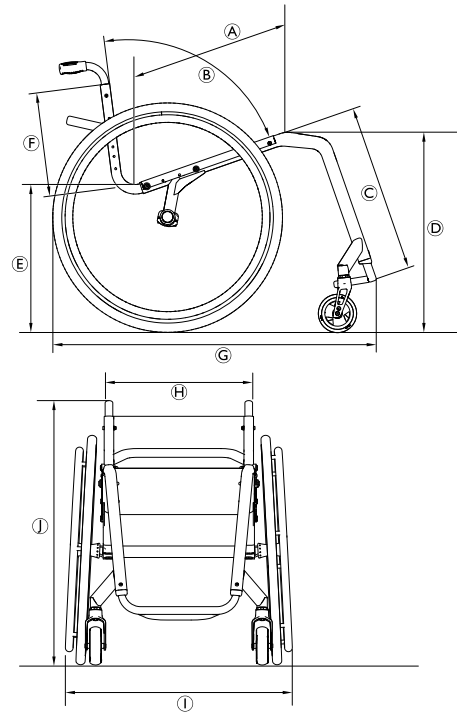

	Maximum user weight	100 kg
Ⓐ	Seat depth	385 – 485 mm, in increments of 25 mm
Ⓑ	Backrest angle	74°/78°/82°/86°/90°
Ⓒ	Lower leg length	350 – 500 mm, in increments of 10 mm
Ⓓ	Front seat-to-floor height	450 – 530 mm, in increments of 10 mm
Ⓔ	Rear seat-to-floor height	400 – 480 mm, in increments of 10 mm
Ⓕ	Backrest height	270 – 420 mm, in increments of 15 mm
Ⓖ	Overall length with legrest	75° frame angle: approx. 800 mm 90° frame angle: approx. 730 mm
Ⓗ	Seat width	340 – 440 mm, in increments of 20 mm
Ⓘ	Overall width	Seat width + 170 mm
Ⓢ	Overall height	approx. 650 – 1200 mm
	Folded height	approx. 600 – 710 mm
	Total weight	approx. 6,8 kg
	Weight of the heaviest part	4,3 kg

	Pivot width	1240 mm
	Minimum turning radius	700 mm
	Max. safe slope	7°
	Static stability downhill	20°
	Static stability uphill	7°
	Static stability sideways	20°
	Seat plane angle	0° – 20°
	Leg to seat surface angle	55° – 115°
	Armrest to seat distance	120 – 280 mm
	Front location of armrest structure	220 – 330 mm
	Handrim diameter	approx. 520 – 580 mm
	Horizontal location of axle	approx. –20 to +140 mm

## 11.2 Tyres

The ideal tyre pressure depends on the tyre type.

The table below is an indication. In case the tyre differs from the list below, check the side of the tyre, the maximum pressure is often listed there.

Tyre	Diameter	Max. pressure		
		7 bar	700 kPa	101 psi
Profile tyre	610 mm (24")			
Other tyres	610 mm (24"); 635 mm (25"); 660 mm (26")	10 bar	1000 kPa	145 psi

 The compatibility of the tyres listed above depends on the configuration and/or model of your wheelchair.

 In case of a tyre puncture consult a suitable workshop (e.g. bike repair shop, bicycle dealer ...) to have the tube replaced by a skilled person.

 The size of the tyre is mentioned on the sidewall of the tyre. The change of appropriate tyres must be carried out by a qualified technician.



### CAUTION!

– The tyres pressure needs to be equal in both wheels to avoid decreased driving comfort, to keep the parking brakes working properly and to ease propelling of the wheelchair.

## 11.3 Materials

The components used to manufacture KÜSCHALL wheelchairs consist of following materials:

Frame tubes	Aluminum
Backrest tubes	Aluminum
Axle tube	Carbon Fiber
Seat cover / Backrest cover	PA / PE / PVC
Push handles	Aluminum / TPE
Clothes guard / Mudguard	Carbon Fiber or Plastic
Castor forks	Aluminum
Footrest tube	Aluminum / Titanium
Footplate	Carbon Fiber or Plastic
Supporting parts / Attachments	Steel / Aluminum
Screws and bolts	Steel

 All materials used are protected against corrosion. We use only REACH compliant materials and components.

 Theft and metal detection systems: in seldom cases the materials used in the wheelchair may activate theft and metal detection systems.

## 11.4 Environmental conditions

	Storage and transportation	Operation
Temperature	-20 °C to 40 °C	-5 °C to 40 °C

Relative humidity	20 % to 90 % at 30 °C, not condensing
Atmospheric pressure	800 hPa to 1060 hPa



Be aware that when a wheelchair has been stored under low temperatures, it must be adjusted to chapter 8 *Maintenance*, page 34 before use.





## Invacare distributors

### Asia:

Invacare Asia Ltd.  
1 Lenton Place, North Rocks NSW 2151  
Australia  
Phone: (61) (02) 8839 5333  
Fax: (61) (02) 8839 5343  
asiasales@invacare.com  
www.invacare.com

### Ireland:

Invacare Ireland Ltd,  
Unit 5 Seatown Business Campus  
Seatown Road, Swords, County Dublin  
EirCode: K67 K271 — Ireland  
Tel : (353) 1 810 7084  
Fax: (353) 1 810 7085  
ordersireland@invacare.com  
www.invacare.ie

### United Kingdom:

Invacare Limited  
Pencoed Technology Park, Pencoed  
Bridgend CF35 5AQ  
Tel: (44) (0) 1656 776 222  
Fax: (44) (0) 1656 776 220  
uk@invacare.com  
www.invacare.co.uk

### Australia:

Invacare Australia Pty. Ltd.  
1 Lenton Place, North Rocks NSW 2151  
Australia  
Phone: 1800 460 460  
Fax: 1800 814 367  
orders@invacare.com.au  
www.invacare.com.au

### New Zealand:

Invacare New Zealand Ltd  
4 Westfield Place, Mt Wellington 1060  
New Zealand  
Phone: 0800 468 222  
Fax: 0800 807 788  
sales@invacare.co.nz  
www.invacare.co.nz



Invacare France Operations SAS  
Route de St Roch  
F-37230 Fondettes  
France

1659269-C 2021-10-28



**Making Life's Experiences Possible®**

**Küschall®**  
UNLIMIT YOUR WORLD