



Yes, you can.™

Invacare Matrix ELITE E2S/E2D BACK REMOVABLE HARDWARE



DEALER: This manual **MUST** be given to the user of the product.

USER: Before using this product, read this entire manual and save for future reference.

i IMPORTANT! The installation instructions contained in this manual must only be carried out by a qualified service technician.



TRD0552 Rev B

USER MANUAL

WARRANTY

PLEASE NOTE: THE WARRANTY BELOW HAS BEEN DRAFTED TO COMPLY WITH FEDERAL LAW APPLICABLE TO PRODUCTS MANUFACTURED AFTER JULY 4, 1975.

This warranty is extended only to the original purchaser/user of our products. This warranty gives you specific legal rights and you may also have other legal rights which vary from state to state. Invacare/Motion Concepts warrants this product to be free from defects in materials and workmanship for two years of use by original purchaser. This warranty does not apply to punctures, tears or burns, nor to the removable cushion cover. If within such warranty period any such product shall be proven to be defective, such product shall be repaired or replaced, at Invacare's/Motion Concepts' option, with refurbished or new parts. This warranty does not include any labor or shipping charges incurred in replacement part installation or repair of any such product. Product repairs shall not extend this warranty-coverage for repaired product shall end when this limited warranty terminates. Invacare's/Motion Concepts' sole obligation and your exclusive remedy under this warranty shall be limited to such repair and/or replacement. For warranty service, please contact the dealer from whom you purchased your Invacare/Motion Concepts product. In the event you do not receive satisfactory warranty service, please write directly to Invacare/Motion Concepts at the address on the back cover. Provide dealer's name, address, model number, the date of purchase, indicate nature of the defect and, if the product is serialized, indicate the serial number.

Invacare Corporation/Motion Concepts will issue a return authorization. The defective unit or parts must be returned for warranty inspection using the serial number, when applicable, as identification within thirty (30) days of return authorization date.

DO NOT return products to our factory without our prior consent. C.O.D. shipments will be refused; please prepay shipping charges.

LIMITATIONS AND EXCLUSIONS: THE WARRANTY SHALL NOT APPLY TO PROBLEMS ARISING FROM NORMAL WEAR OR FAILURE TO ADHERE TO THE ENCLOSED INSTRUCTIONS. IN ADDITION, THE FOREGOING WARRANTY SHALL NOT APPLY TO SERIAL NUMBERED PRODUCTS IF THE SERIAL NUMBER HAS BEEN REMOVED OR DEFACED; PRODUCTS SUBJECTED TO NEGLIGENCE, ACCIDENT, IMPROPER OPERATION, MAINTENANCE OR STORAGE; OR PRODUCTS MODIFIED WITHOUT INVACARE'S/MOTION CONCEPTS' EXPRESS WRITTEN CONSENT INCLUDING, BUT NOT LIMITED TO: MODIFICATION THROUGH THE USE OF UNAUTHORIZED PARTS OR ATTACHMENTS: PRODUCTS DAMAGED BY REASON OF REPAIRS MADE TO ANY COMPONENT WITHOUT THE SPECIFIC CONSENT OF INVACARE/MOTION CONCEPTS; PRODUCTS DAMAGED BY CIRCUMSTANCES BEYOND INVACARE'S/MOTION CONCEPTS' CONTROL; PRODUCTS REPAIRED BY ANYONE OTHER THAN AN INVACARE/ MOTION CONCEPTS DEALER, SUCH EVALUATION SHALL BE SOLELY DETERMINED BY INVACARE/ MOTION CONCEPTS.

THE FOREGOING WARRANTY IS EXCLUSIVE AND IN LIEU OF ALL OTHER EXPRESS WARRANTIES, IF ANY, INCLUDING THE IMPLIED WARRANTIES OF MERCHANTABILITY AND FITNESS FOR A PARTICULAR PURPOSE. IT SHALL NOT EXTEND BEYOND THE DURATION OF THE EXPRESSED WARRANTY PROVIDED HEREIN AND THE REMEDY FOR VIOLATIONS OF ANY IMPLIED WARRANTY SHALL BE LIMITED TO REPAIR OR REPLACEMENT OF THE DEFECTIVE PRODUCT PURSUANT TO THE TERMS CONTAINED HEREIN. INVACARE/MOTION CONCEPTS SHALL NOT BE LIABLE FOR ANY CONSEQUENTIAL OR INCIDENTAL DAMAGES WHATSOEVER. THIS WARRANTY SHALL BE EXTENDED TO COMPLY WITH STATE/PROVINCIAL LAWS AND REQUIREMENTS.

This manual may not be reproduced or reprinted either partly or completely without previous written consent from Motion Concepts or its statutory representatives.

This user manual is compiled from the latest specifications and product information available at the time of publication. We reserve the right to make any necessary as they become necessary. Any changes made to our products may cause slight variations between the illustrations and explanations in this manual and the product you have purchased. If you have any questions or concerns regarding the information provided in this manual, please contact our Customer Service Department for assistance.

1.0 GENERAL WARNINGS/INFORMATION

1.1 OVERVIEW

SAFETY SYMBOLS:

Proper set-up and safe use of your Invacare Matrix Elite E2S/E2D Back depends on your own good judgement and common sense, as well as that of your provider, caregiver and/or health professional. The following symbols are used throughout this user manual to identify warnings, cautions and important notes. It is very important that you read and understand them completely.

 **CAUTION!** Failure to heed the cautions in this manual may result in damage to your Matrix Seating product.

 **WARNING!** Failure to heed the warnings in this manual may result in death, serious injury or damage.

 **IMPORTANT!** Important information to remember during installation, set-up and/or adjustment of you Matrix Seating product.

USER WARNING!

Improper use of this product may cause injury or damage. DO NOT use this product or any available optional equipment without first completely reading and understanding these instructions and any additional instructional material such as user manual, service manuals or instruction sheets supplied with this product or optional equipment. If you are unable to understand the warnings, cautions or instructions, contact a health care professional or dealer before attempting to use this equipment.

IMPORTANT INFORMATION

The best way to avoid problems related to pressure injuries is to understand their causes and your role in a skin management program. Your therapist and physician should be consulted if you have questions regarding individual limitations and needs. All back supports should be selected carefully. Working with your therapist and physician is the best way to assure that a cushion choice matches your individual needs. As the needs of the individual become more complex, the evaluation becomes more important.

 **IMPORTANT!** Please refer to the Wheelchair Owners/Operators Manual for additional safety information, warnings and cautions related to the operation of your wheelchair.

1.2 INTENDED USE

Our Invacare® Matrix® Elite E2S and E2D back is intended to provide back support for a wide variety of wheelchair users. It is designed to allow precise orientation within a wheelchair to ensure optimal postural support and positioning. The E2S/E2D Back support can be installed on a wide range of wheelchairs.

2.0 SAFETY INFORMATION

2.1 TRANSPORTATION WARNINGS!

▲ WARNING! Risk of Death, Serious Injury or Damage

- Risk of severe injury when transporting the client within a wheelchair fitted with an Invacare® Matrx® Elite E2S/E2D back in a motor vehicle.

TRANSPORTING THE CLIENT IN A MOTOR VEHICLE WITHIN A WHEELCHAIR FITTED WITH A MATRX BACK

The following guidelines should be made available to all parties responsible for the transportation of the client, such as schools and transport providers.

- Wherever practicable Motion Concepts recommends that the client is transferred out of the wheelchair into a vehicle seat using a lap and diagonal seat belt or an appropriate child safety seat.
- The following back supports have been dynamically tested and meet the requirements of ISO 16840-4:2009, Wheelchair Seating- Part 4: Seating Systems for Use in Motor Vehicles; and Section 20, ANSI/RESNA WC-4:2017, Wheelchair Seating Systems for Use in Motor Vehicles:
 - Invacare® Matrx® Elite E2S back with Removable Hardware and Elan Headrest
 - Invacare® Matrx® Elite E2S back with Fixed Hardware and Elan Headrest

A forward facing frontal impact test was performed for each configuration using an ISO/RESNA Surrogate Wheelchair Frame (SWCF) and a Hybrid III Midsize-Adult Male Anthropomorphic Test Device (ATD). The SWCF was secured by a four-point, strap type wheelchair tie-down and the ATD was restrained by a surrogate three-point belt with a SWCF-Anchored Lap Belt.

- Invacare® Matrx® Elite E2S/E2D backs used to transport a client **must** be equipped with a Headrest Support (i.e. restricted to back heights 14in (36cm) and higher); and may **only** be used in conjunction with wheelchairs that comply with the performance requirements of RESNA WC19 or ISO 7176-19.
- For safe transportation of a client within a wheelchair in a motorvehicle, refer to the user manuals of the wheelchair and tie-down and occupant restraint system (WTORS)- see additional information below.

BEFORE ENTERING THE VEHICLE CHECK THE FOLLOWING:

The Matrx Back must be securely fastened into the wheelchair as described in the user manual.

Posture Belts & Harnesses should remain fitted during transportation, although they are designed to provide postural support only, they are NOT intended for safety during transportation.

A Head Support must be securely fitted and correctly adjusted close to the rear of the client's head during transportation, to reduce the risk of whiplash injuries.

WHEELCHAIR TIE-DOWN & OCCUPANT RESTRAINT SYSTEM (WTORS)

- **Wheelchair Tie-down:** The wheelchair must be securely tied down within the vehicle, in a forward facing position, in accordance with the wheelchair and tie-down manufacturers instructions.
- **Occupant Restraint:** A suitable occupant restraint system must also be fitted in accordance with the manufacturer's instructions. A minimum is a lap and diagonal

belt (lap belts on their own are not suitable). Restraints that loop over the shoulder and anchor to the vehicle floor should be avoided where possible, as they can cause a heavy downward load through the client during an impact, the preferred type anchor above and behind the shoulder as with a car seat belt. The lap section of the belt should fit snugly over the pelvis of the client and should not be able to ride up to the abdominal area. The upper torso section of belt should be in contact with the client's chest and fit over the shoulder(s), while not cutting into the neck or slipping off the shoulder(s).

i IMPORTANT! If the wheelchair and Invacare® Matrx® Elite E2S/E2D back is transported unoccupied, the wheelchair should be tied down with suitable equipment according to the manufacturer's instructions. If the equipment is dismantled for transportation, ensure that all parts are secured safely within the vehicle.

2.2 GENERAL SAFETY AND INSTALLATION WARNINGS!

⚠ WARNING! Risk of Death, Serious Injury, or Damage

Lighted cigarettes dropped onto an upholstered seating system can cause a fire resulting in death, serious injury or damage. Wheelchair occupants are at particular risk of death or serious injury from these fires and resulting fumes because they may not have the ability to move away from the wheelchair.

- DO NOT smoke while using this wheelchair

⚠ WARNING! Risk of Serious Injury

When establishing the mounting position for the Invacare® Matrx® back, ensure the stability of the wheelchair is not compromised. Adjusting the forward and aft position and/or angle of the backrest will alter the user's center of gravity within the wheelchair. It may be necessary to reposition the front casters, rear wheels, back angle, tilt-in-space, recline position and/or seat depth before use.

⚠ WARNING! Risk of Serious Injury or Damage

- The procedures in this manual should be performed by a qualified technician
- The hardware provided is high strength and tested for durability. **Do Not substitute hardware.** Use only the original hardware supplied with your Matrx back
- Attaching hardware that is loosely secured could cause loss of stability resulting in serious injury or damage.
- After ANY adjustments, repair or service and before use, make sure that all attaching hardware is tightened securely.
- DO NOT install the Invacare® Matrx® back assembly onto back canes with an outside diameter greater than 1" (25mm) or less than 3/4" (19mm). Otherwise, injury or damage may occur.
- For power seating applications, the Fixed Mounting Hardware must be used.

⚠ WARNING! Risk of Injury

Invacare® Matrx® products are specifically designed and manufactured for use in conjunction with Invacare® Matrx® accessories. Accessories designed by other manufacturers have not been tested by Motion Concepts and are not recommended.

⚠ WARNING Risk of Injury

Skin condition should be checked very frequently after the installation of any new seating system. Working with you therapist, physician and service provider is the best way to assure that a seating choice meets your individual needs.

3.0 MATRX ELITE E2S/E2D BACK INSTALLATION

3.1 FITTING THE E2S/E2D BACK TO THE WHEELCHAIR:

PRIOR to installation, verify the diameter of the wheelchair back canes (**A**) and the width between back canes (**B**)

| Model # | Description | Contour Depth |
|---------|---------------------|---------------|
| E2Swwhh | Matrx Elite E2 | 3in (8cm) |
| E2Dwwhh | Matrx Elite E2 Deep | 6in (15cm) |

*wwhh = width/height

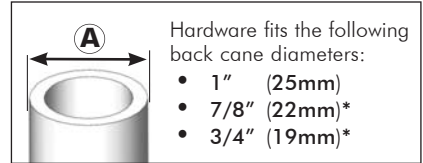

| E2S/E2D Back Width | FITS ONTO BACK CANE WIDTH (B) | | |
|--------------------|-------------------------------|-------------------|-------------------|
| | Min Width | MiniSet Max Width | EasySet Max Width |
| 14in (36cm) | 13in (33cm) | 15in (38cm) | 16in (41cm) |
| 15in (38cm) | 14in (36cm) | 16in (41cm) | 17in (43cm) |
| 16in (41cm) | 15in (38cm) | 17in (43cm) | 18in (46cm) |
| 17in (43cm) | 16in (41cm) | 18in (46cm) | 19in (48cm) |
| 18in (46cm) | 17in (43cm) | 19in (48cm) | 20in (51cm) |
| 19in (48cm) | 18in (46cm) | 20in (51cm) | 21in (53cm) |
| 20in (51cm) | 19in (48cm) | 21in (53cm) | 22in (56cm) |

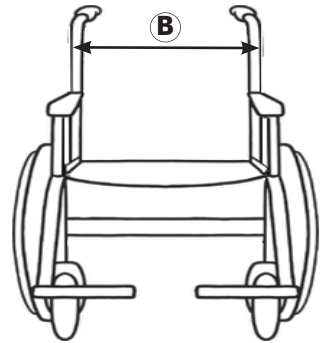

The type of Mounting Hardware can vary depending on several factors, including the height of the back shell, the needs of the end user and the type of wheelchair.

| E2S/E2D Back Height | STANDARD Hardware | OPTIONAL Mounting Hardware | | | Weight Capacity |
|---------------------|---|--|---|--|-----------------|
| | Removable | Heavy-Duty | Fixed | Split | |
| 6in (15cm) | MiniSet -see Installation Instruction TRD0552 | HD MiniSet -see Installation Instruction TRD0552 | FIXED MiniSet -see Installation Instruction TRD0566 | N/A | 300lb (136kg) |
| 8in (20cm) | | | | | |
| 10in (26cm) | | | | | |
| 12in (31cm)* | | | | | |
| 14in (36cm)* | | | | | |
| 16in (41cm)* | EasySet -see Installation Instruction TRD0552 | HD EasySet -see Installation Instruction TRD0552 | FIXED EasySet -see Installation Instruction TRD0566 | SPLIT Hardware -see Installation Instruction TRD0247 | 300lb (136kg) |
| 18in (46cm) | | | | | |
| 20in (51cm) | | | | | |

***Note:** E2S/E2D Backs may be configured with EasySet hardware for the back heights indicated. (The range of back height adjustment will be limited for these configurations)

3.2 STANDARD (OR HEAVY-DUTY) REMOVABLE HARDWARE:

i **NOTE:** If any of the supplied hardware is missing or misplaced, please contact your local Service Provider to obtain the necessary replacements.

3.2.1 MINISET REMOVABLE HARDWARE

Standard Mounting Hardware Kit for Back Heights **16" (41cm) or less**

- 2 - MiniSet Std. Mounting Plate (A1) **or**
- 2 - MiniSet HD Mounting Plate (A2) (not shown)
- 2 - Cane Clamp Ass'y (B)
- 2 - Cane Inserts 7/8" (22mm) (C)
- 2 - Cane Inserts 3/4" (19mm) (D)
- 4 - Depth/Angle Adjustment Screws (E)
- 2 - Cane Clamp Screw/Washer (F)
- 2 - Cane Clamp Nut Plate (G)

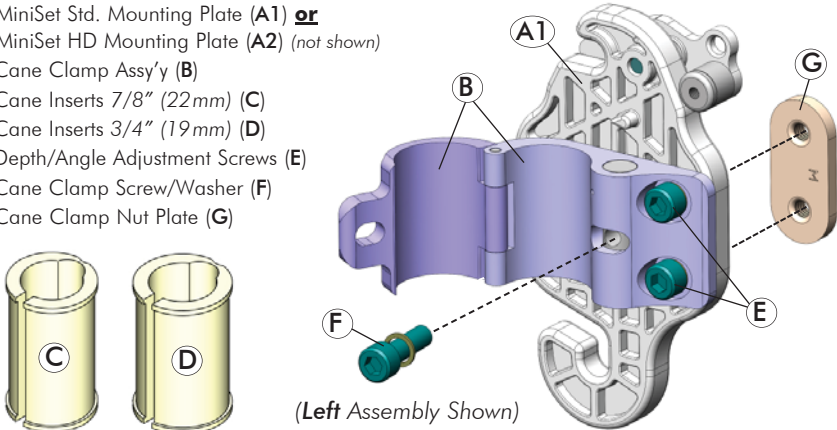

3.2.2 EASYSET REMOVABLE HARDWARE

Standard Mounting Hardware Kit for Back Heights **18" (46cm) or greater**
(Optional Mounting Hardware Kit for Back Heights 12/14/16" (31/36/41cm))

- 2 - EasySet Std. Mounting Plates (A1) **or**
- 2 - EasySet HD Mounting Plates (A2) (not shown)
- 2 - Cane Clamp Ass'y (B)
- 2 - Cane Inserts 7/8" (22mm) (C)
- 2 - Cane Inserts 3/4" (19mm) (D)
- 2 - Set Screws (E)
- 6 - Depth/Angle Adjustment Screws (F)
- 6 - Cane Clamp Screws/Washers (G)
- 2 - Cane Clamp Nut Plate (H)

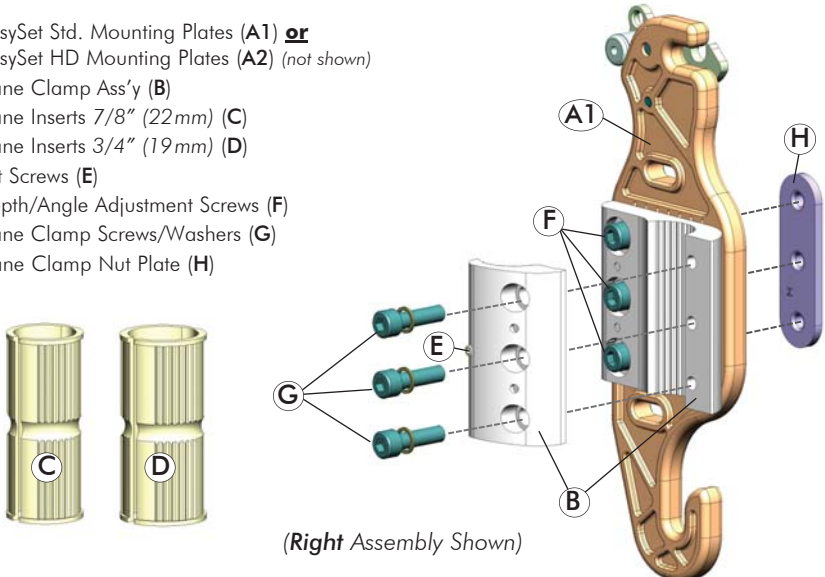

1Note: The range of back height adjustment will be limited/reduced when using these non-standard (optional) hardware configurations.

3.3 CANE CLAMP ORIENTATION

The orientation of the Cane Clamps (A) provides approximately 4" (102mm) of fore/aft adjustment. PRIOR to installing the Cane Clamps, determine the cane clamp orientation that will best meet the needs of the end user.

- Standard Orientation (Fig. 1a/2a) = maximized seat depth
- Inverted Orientation (Fig. 1b/2b) = minimized seat depth

Note: Additional depth adjustments can be made via the slotted channels in the mounting plates - see section 3.5.3.

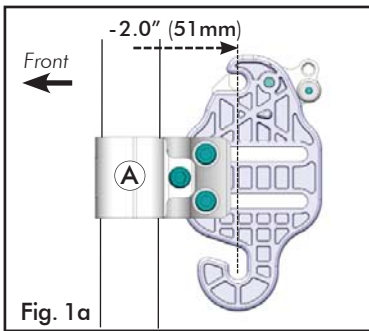

Fig. 1a

Standard Orientation

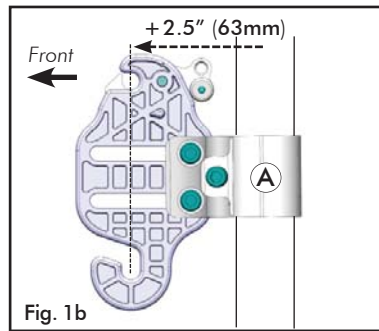

Fig. 1b

Inverted* Orientation

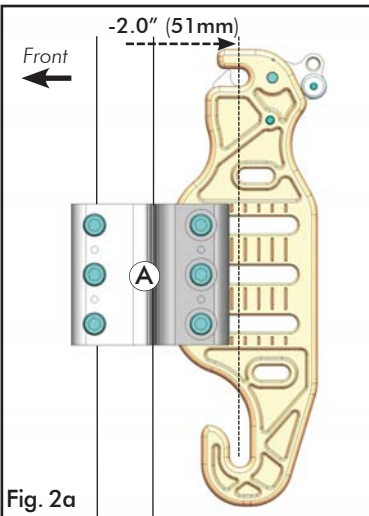

Fig. 2a

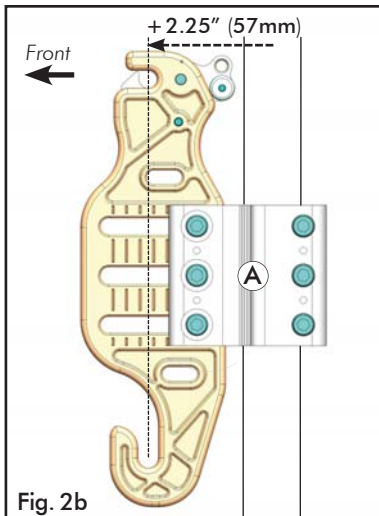

Fig. 2b

(*Requires the mounting plate to be disassembled from the cane clamp and rotated 180°)

3.4 CANE CLAMP INSTALLATION (see Fig. 3a/3b; Fig 4a/4b)

i NOTE: The mounting position of the cane clamps should be estimated so that, when installed, the installed Elite E2S/E2D back will be close to the desired back height. A higher cane clamp mounting position typically works best. Additional fine-tune height adjustment of the back shell will be available following installation.

1. (If applicable) Remove existing wheelchair back according to the wheelchair manufacturers instructions.
2. Install the MiniSet **or** EasySet Cane Clamps onto each back cane as follows:
 - (If necessary) Install the appropriate cane insert onto the back cane (1).
 - Position/close the outer clamp (A) over the back cane (cane insert) and align it with the inner clamp (B).
 - Loosely secure the clamp assembly to the back cane via the mounting screw(s) (2).
 - Adjust the height* of each clamp assembly (3) equally along the back canes in order to achieve the estimated final back height.
 - Fully secure all cane clamp mounting screws (2)

***Note:** The final back height can be further adjusted (via mounting brackets) following installation of the Elite E2S/E2D back- see **section 3.5.2**

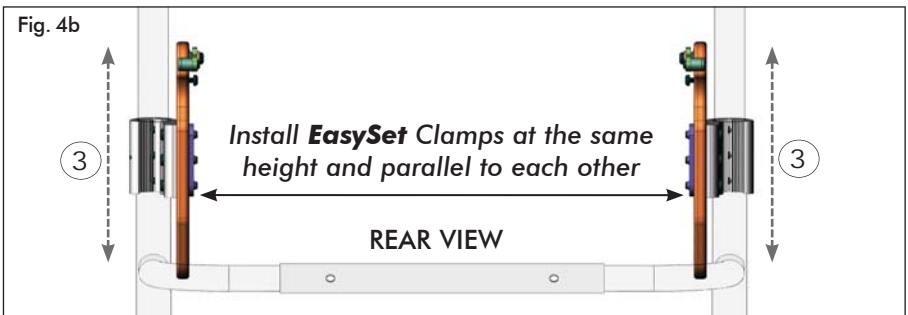
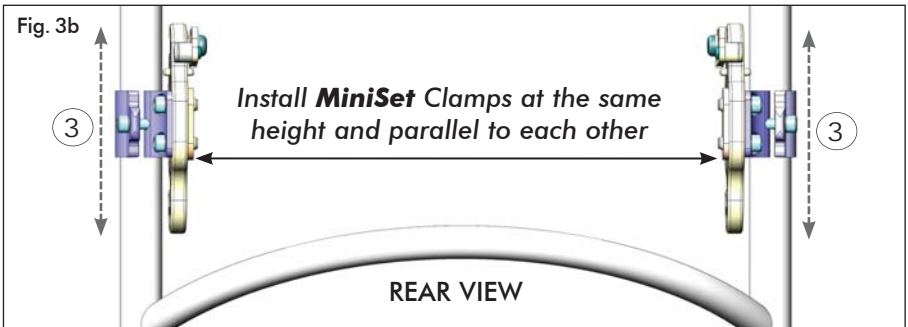
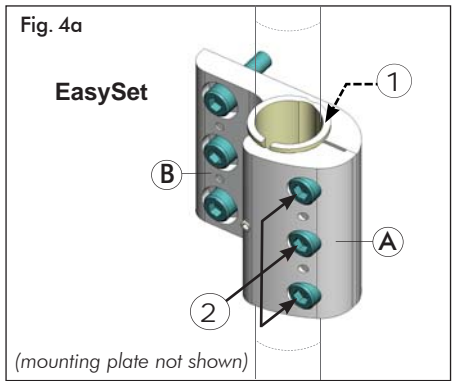
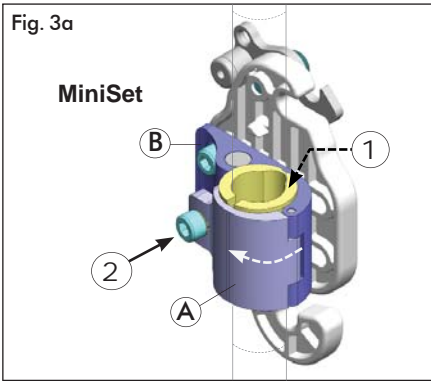

3.5 INSTALLING THE ELITE E2S/E2D BACK

⚠ WARNING! Risk of Damage or Injury

NEVER use loctite/thread-locker on non-metal components/hardware; Non-metal components may degrade and become brittle (break) if contaminated.

⚠ WARNING! Risk of Serious Injury or Damage

When installed, ALWAYS ensure both latch mechanisms on the removable mounting hardware are fully engaged/locked around the upper mounting pins.

i IMPORTANT! Unless otherwise necessary, **always** ensure that adjustments are made **symmetrically** on the left and right mounting brackets.

i IMPORTANT! The **MiniSet** mounting brackets allow for installation of the E2S/E2D back onto back canes up to **1" (25mm) wider or 1" (25mm) narrower** than than the nominal back width. The **EasySet** mounting brackets allow installation of the E2S/E2D Back onto back canes up to **2" (51mm) wider or 1" (25mm) narrower** than than the nominal back width.

! PLEASE NOTE

*The E2 Mounting Brackets will simultaneously adjust the **Width and Height** of the back (relative to the back canes). Please read through ALL set-up/adjustment instructions, **PRIOR** to beginning the E2S/E2D Back installation.*

3.5.1 MOUNTING BRACKET SET-UP/ PRELIMINARY BACK INSTALLATION:

i NOTE: The Preliminary Set-up should be performed without the user seated in the chair

Mounting Bracket Set-Up: (see Fig. 5a/5b)

1. Loosen the adjustment screws (**A**) and adjust both mounting brackets (**B**) horizontally (**1**) so that the mounting pins (**C**) will align with the mounting plates (**D**) on the wheelchair back canes.

Preliminary Installation: (see Fig. 6)

2. Install the Elite E2S/E2D back onto the mounting plates (**2**). (**note:** the preliminary installation steps are identical for the MiniSet and EasySet hardware).
 - Align/install the lower mounting pins (**C2**) into the hooked slots at the bottom of each mounting plate (**D**).
 - Lock the upper mounting pins (**C1**) into the latch mechanism (**E**) at the top of each mounting plate (**D**).
3. Proceed to section **3.5.2 Back Height & Width Adjustments**.

E2 Mounting Bracket Set-Up:

Fig. 5a

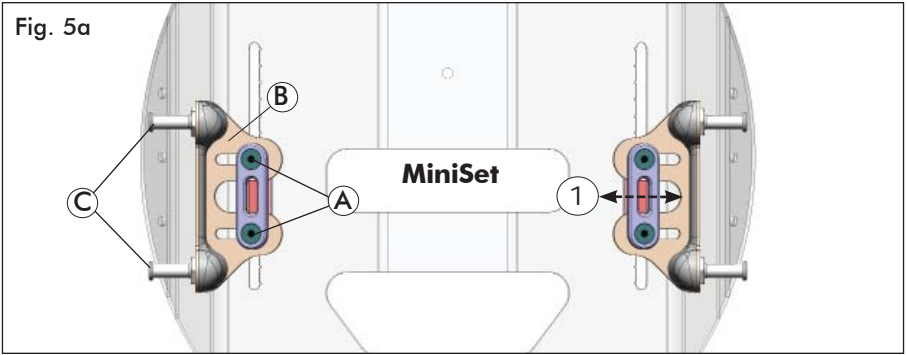
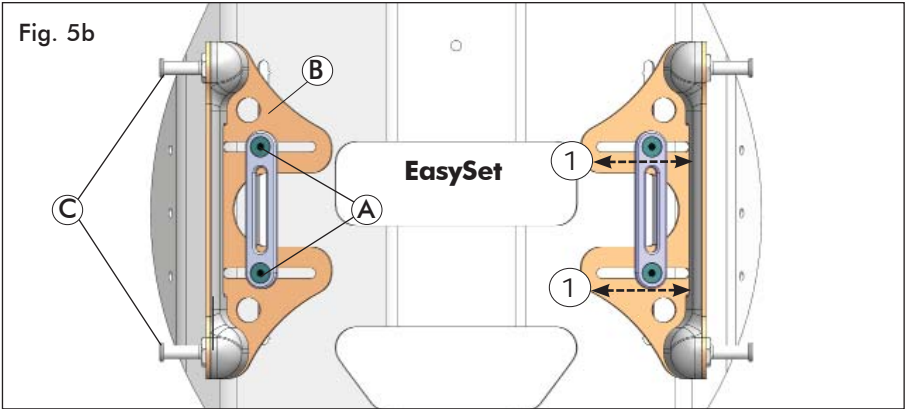
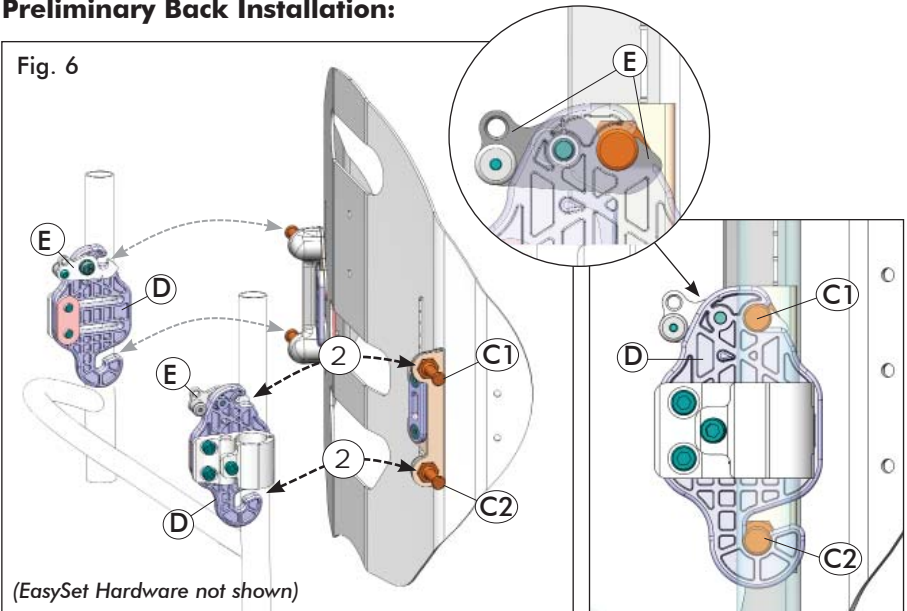

Fig. 5b



Preliminary Back Installation:

Fig. 6



3.5.2 BACK HEIGHT AND WIDTH ADJUSTMENT:

⚠ WARNING! Risk of Damage or Injury

Improper mounting pin set-up may cause damage to the back pan and/or the mounting plates. Ensure sufficient space is provided between the mounting plate and the heads of the mounting pins (a minimum gap of 1/8" -1/4" (3mm-6mm) is recommended).

The vertical (height) adjustment slots on each E2S/E2D back shell will vary in length depending on the nominal back height- refer to **Table 1**.

Table 1. BACK SHELL: RANGE OF HEIGHT ADJUSTMENT

| Back Height | Adjustment Range | Back Height | Adjustment Range |
|-------------|------------------|---------------------|------------------|
| 6" (15cm) | 1.25" (32mm) | 12" (31cm) | 2.5" (63mm) |
| 8" (23cm) | 1.5" (38mm) | 14", 16" (36, 41cm) | 3.5" (89mm) |
| 10" (26cm) | 2.0" (51mm) | 18", 20" (46, 51cm) | 3.25" (83mm) |

ⓘ NOTE: During final set-up, we recommend having the end user seated in the wheelchair to best fit/position the Elite E2S/E2D back.

Back Height and Width Adjustment: (see Fig. 7, Fig. 8)

1. With the E2S/E2D back locked into place, and the end user seated in the chair (if possible), carefully adjust the back shell along the vertical adjustment slot (A)(1) until the desired back height is achieved.

NOTE: the minimum recommended back height is 4"- 5" (10-13cm) from the top of the seat surface.*

2. While maintaining the desired back height, adjust each mounting bracket (B) horizontally (2) so that a **minimum gap of 1/8-1/4" (3-6mm)** exists between the heads of the mounting pins (C) and the mounting plate (D).

NOTE: Unless otherwise necessary, the Elite E2S/E2D back should be centered between the back canes during installation.

3. Once all height and width adjustments are finalized, fully tighten/secure both mounting brackets into position.
4. Proceed to section 3.5.3 for **Back Angle and Depth Adjustment**

***Note:** The minimum recommended back height is provided as a guideline only. The final back height should be adjusted/set to best meet the end user's needs-see **Important!** note below.

ⓘ IMPORTANT! Always ensure that the bottom of the back is positioned anatomically below the Posterior Superior Iliac Spine (PSIS). If you have any questions or concerns regarding proper back height adjustment, please contact your Motion Concepts representative for assistance.

Back Height and Width Adjustments

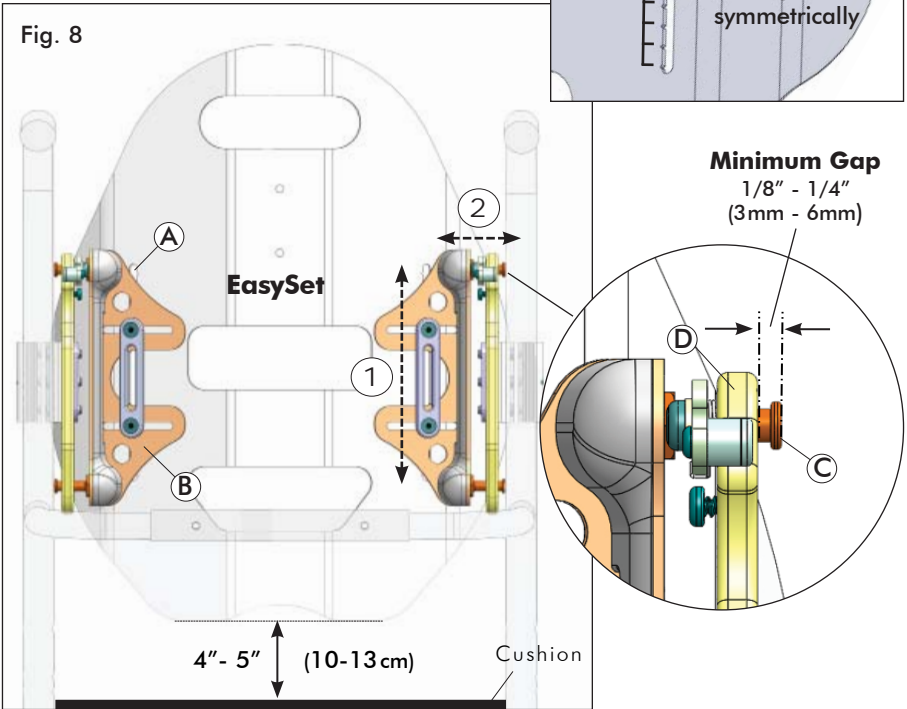
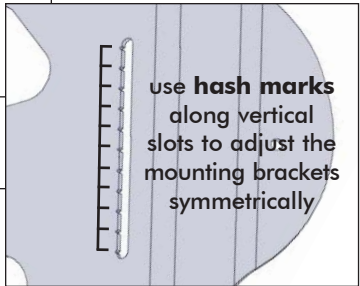
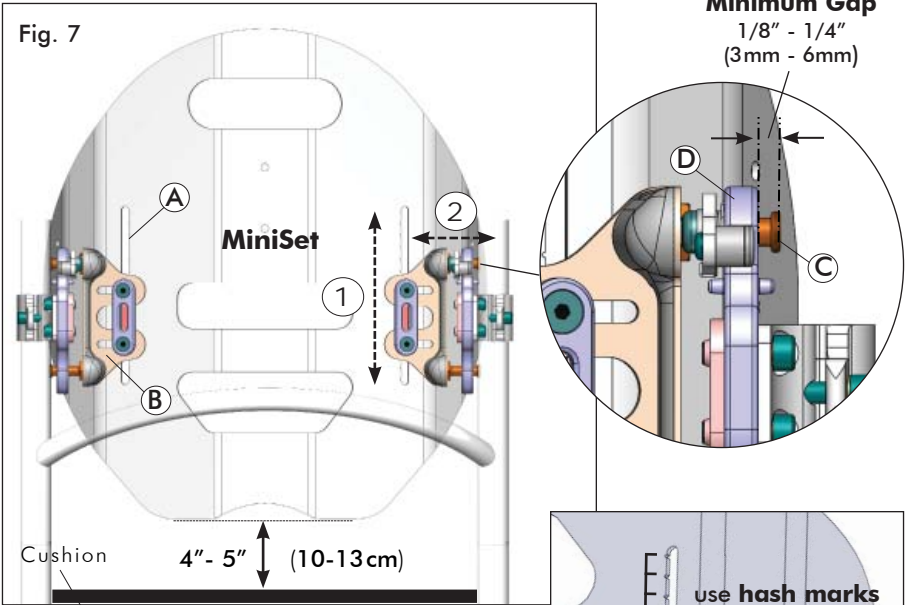

3.5.3 BACK ANGLE AND DEPTH ADJUSTMENTS

! PLEASE NOTE

Angle and Depth adjustments on the are made simultaneously via the adjustment screw(s) on the left and right cane clamp assemblies. Unless otherwise required, depth and angle adjustments should be made equally/symmetrically on both mounting plates.

Back Angle Adjustment: (see Fig. 9; Fig. 10)

1. Loosen the depth/angle adjustment screws (A) on each clamp assembly (B), and rotate the mounting plates (C) to achieve the desired back angle.

- RANGE OF ANGLE ADJUSTMENT = $\pm 20^\circ$

i Note: When adjusting the back angle, the vertical lines in the mounting plates may be used as reference to make equal adjustments on each mounting plate.

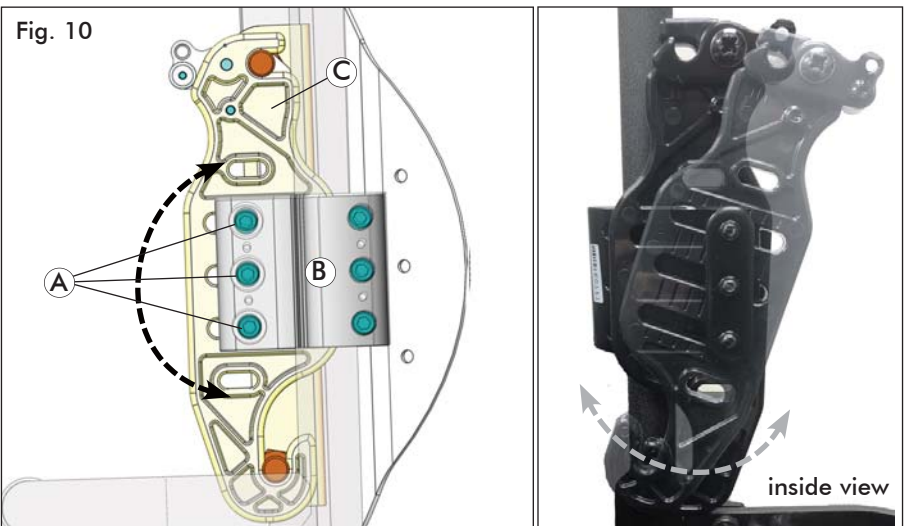
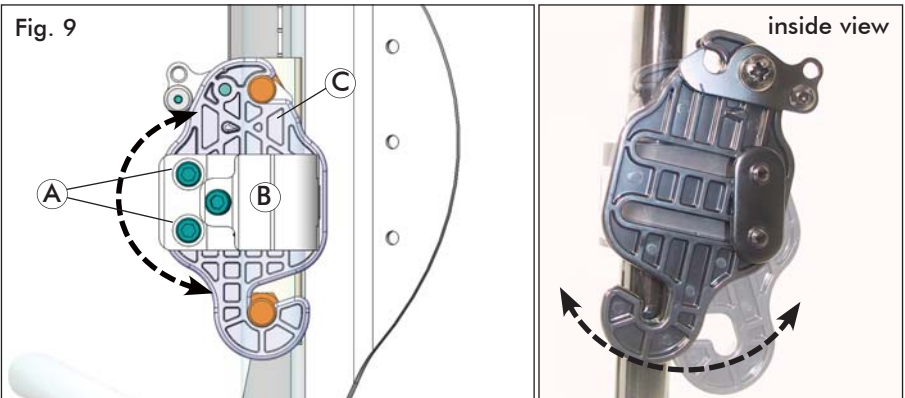

Back Depth Adjustment: (see Fig. 11; Fig. 12)

- Loosen the depth/angle adjustment screw(s) (A) on each clamp assembly, and adjust the fore/aft position of the Elite E2S/E2D Back (mounting plate) (B) via the depth adjustment slots (1).

RANGE OF MOUNTING PLATE DEPTH ADJUSTMENT:

- MiniSet = 1.75" (44mm)
- EasySet = 1.5" (38mm)

NOTE: The final back depth (fore/aft position) is also determined by the cane clamp orientation (see Section 3.3). The standard clamp orientation is illustrated below

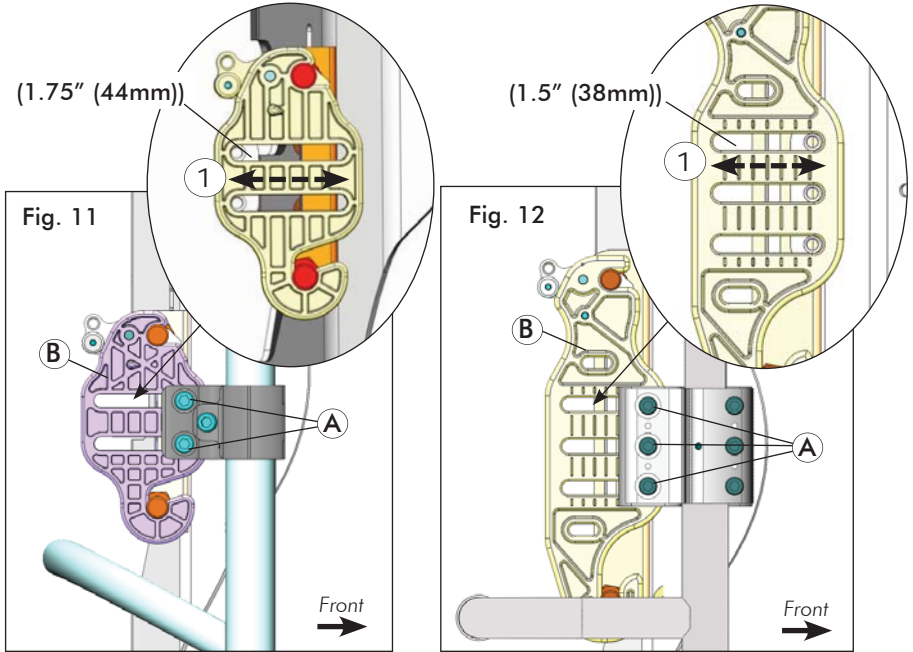

i NOTE: The range of depth adjustment will be reduced when the angle of the Elite E2S/E2D back (mounting plate) is altered.

- Once all angle/depth adjustments are finalized, fully secure **ALL** mounting hardware.

3.6 REMOVING THE ELITE E2S/E2D BACK

Removing/Disengaging the Elite E2S/E2D Back: (see Fig. 13; Fig. 14)

1. To disengage the upper mounting pins, simultaneously lift upward (1) on both latch mechanisms (A), then pull/push forward (2) on the top of the back support to release the upper mounting pins (C1) from the mounting plates (B).
2. Remove the Elite E2S/E2D back by lifting up and forward (3) on the back support to release the lower mounting pins (C2).

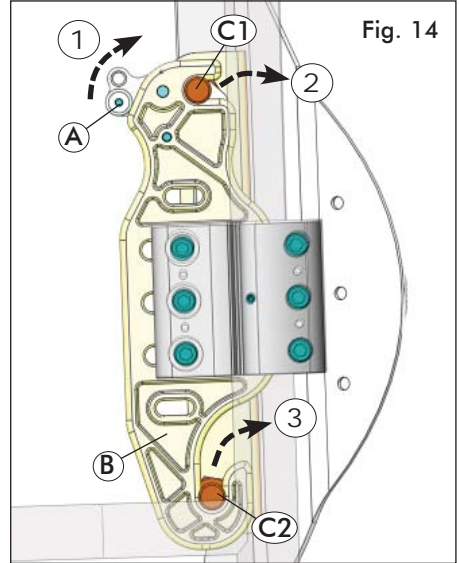
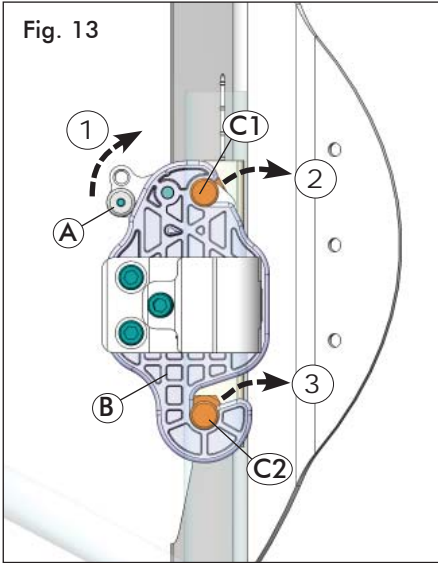

4.0 CARE AND MAINTENANCE

4.1 INSPECTION AND MAINTENANCE

⚠ WARNING! Risk of Injury or Damage

DO NOT continue to use this product if problems are discovered. Corrective measures can be performed at, or arranged through your service provider.

Weekly: Inspect ALL fasteners weekly to ensure that mechanical connections and attaching hardware are tightened securely.

Monthly: Perform a visual inspection of parts including hardware, brackets, upholstery materials, foam, and plastics for deformation, corrosion, breakage, wear or compression.

4.2 CLEANING/LAUNDERING:

⚠ WARNING! Risk of Injury or Damage

To avoid infectious exposure, inspect cushion thoroughly and properly clean and disinfect any materials soiled with bodily fluids.

⚠ CAUTION! Risk of Damage

- DO NOT use cleaning agents containing phenols, alcohols, bleaches or other abrasive materials. Otherwise product damage may occur.
- 1% Chlorine Solution used on a regular basis can diminish the life of the cover if not rinsed and dried properly. Do not use granules.
- All cleaning agents and disinfectants used must be effective, compatible with one another and must protect the materials they are used to clean.
- Keep clear of open heat sources during cleaning.

General Care and Cleaning (Light Soilage):

1. The outer cover may be easily wiped down with a damp cloth using a 0.1% Chlorine Solution (1,000 ppm).
2. Rinse the outer cover with clean water using a single use nonabrasive cloth.
3. Dry the outer cover thoroughly before re-fitting to foam.

Laundering the Outer Cover:

PRIOR to laundering, the inner foam cushion must be removed from the cover.

1. Carefully remove the cover by releasing the velcro hook & loop fasteners along the top, bottom and inside of the back shell.
2. Machine wash cover in warm water (60C) on the Gentle Cycle.
3. Drip Dry **or** Tumble Dry on Low Heat (Dry cover thoroughly before re-fitting foam)

i NOTE: Do Not Dry Clean, Do Not Iron, Do Not Bleach

Cleaning the Back Shell/Hardware:

1. The back shell and hardware/components can be wiped clean with soap and water as necessary.

4.3 REUSE/RECYCLING

⚠ WARNING! Risk of Injury

Always have an authorized dealer inspect the product for damage or wear PRIOR to transferring the product to a different user. If any damage is found, DO NOT use this product. Failure to heed these warnings may result in severe injury.

This product is suitable for re-use. The outer cover (fabric and foam), back shell and mounting hardware must be inspected by a qualified dealer or healthcare professional before re-use. If any damage is found, DO NOT RE-USE

Clean and disinfect all components (cover, foam, hardware and back shell) in accordance with local government regulations, prior to re-use. For further assistance and/or information on decontamination and disinfection, please consult your local Infection Control Office.

4.4 DISPOSAL

The disposal and recycling of used devices and packaging must comply with the applicable local legal regulations.

5.0 ELITE E2S/E2D ACCESSORIES

5.1 E2 HEADREST INTERFACE PLATE

The E2 Headrest Interface Plate (A) is included only with Elite E2S/E2D backs for **Back Heights** ranging from **14" (36cm) up to 20" (51cm)**. The E2 headrest interface is compatible with most industry standard headrest mounting hardware, including our **Matrix Elan Headrest Hardware** (sold separately). The headrest interface plate installs directly onto the E2S/E2D back shell using the hardware provided*.

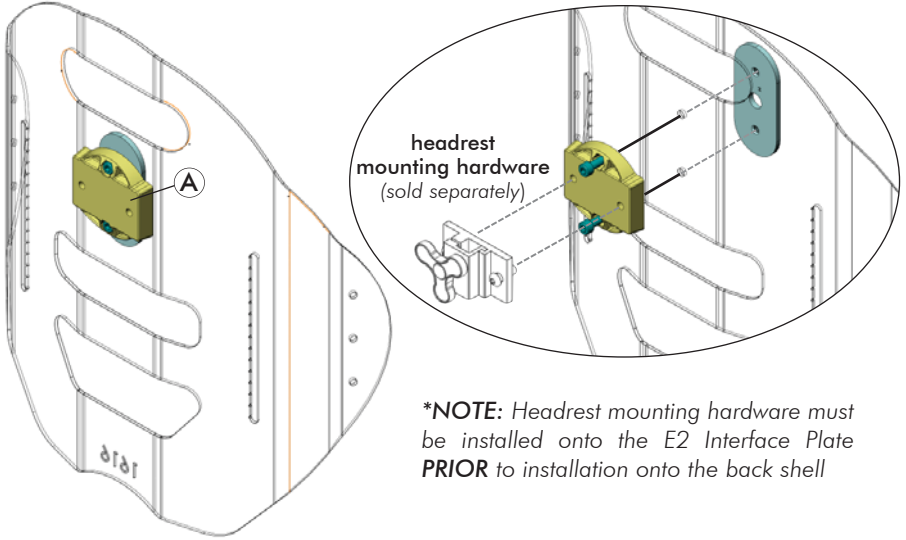

5.2 E2 LUMBAR SUPPORT

The E2 Lumbar Support (A) is included with ALL Elite E2S/E2D backs. The Lumbar Support is a pre-fabricated foam insert that provides optional lower back support for improved positioning and comfort. The lumbar support may be installed inside the Matrix Elite E2S/E2D cover when desired (see *instructions/images below*).

To install the Lumbar Support:

1. Open the outer cover at the bottom rear of the back shell (via the hook and loop fastener).
2. Install the lumbar support inside the E2 back cover (behind the existing foam pad), as illustrated below.
3. Refasten the outer cover onto the back shell.



5.3 ADDITIONAL E2 ACCESSORY OPTIONS (Sold Separately)

- I. PRIVACY FLAP (PFLAP)
- II. BACKBONE (PSIS/SacroLumbar Support)
- III. POSTURE FLEX (Abdominal Support) and QUAD RELEASE (QR) TAB
- IV. CHEST HARNESS INTERFACE
- V. EASYFIX LATERALS
- VI. SWING-AWAY LATERALS





Invacare

www.invacare.com

USA

One Invacare Way
Elyria, Ohio USA
44036-2125
440-329-6000
800-333-6900

Canada

570 Matheson Blvd. E Unit B
Mississauga, Ontario
L4Z 4G4 Canada
800-668-5324



Motion Concepts

www.motionconcepts.com

USA

700 Ensminger Rd. Suite 112
Tonawanda, NY 14150
888-433-6818

Canada

84 Citation Dr., Unit 1-10
Concord, Ontario L4K 3C1
866-748-7943